

P-7 *premium*

PLANETARY MILL

READ THE INSTRUCTIONS PRIOR TO PERFORMING ANY TASK!



Valid starting with: 07.5000/03380

Translation of the original operating instructions

Version 02/2026 Index 007



1	Safety information and use.	7
1.1	Requirements for the user.	7
1.2	Scope of application.	8
1.2.1	Operating principle.	9
1.2.2	Drive motor and speed regulation.	9
1.3	Obligations of the operator.	9
1.4	Information on hazards and symbols used in this manual.	10
1.5	Information on hazards at the device.	12
1.6	Device safety information.	12
1.7	Protective equipment.	14
1.8	Hazardous points.	15
1.9	Electrical safety.	15
1.9.1	General information.	15
1.9.2	Protection against restart.	15
1.9.3	Overload protection.	16
1.9.4	Imbalance detection.	16
2	Technical data.	17
2.1	Dimensions.	17
2.2	Weight.	17
2.3	Operating noise.	17
2.4	Voltage.	17
2.5	Current consumption.	17
2.6	Protection class.	17
2.7	Power consumption.	17
2.8	Electrical fuses.	17
2.9	Material.	18
2.10	Final fineness.	18
3	Installation.	19
3.1	Transport.	19
3.2	Unpacking.	19
3.3	Setting up.	20
3.4	Ambient conditions.	20
3.5	Electrical connection.	21
4	Initial start-up.	22
4.1	Switching on.	22
4.2	Function check.	22
4.3	Switching off.	24

5	Using the device.	25
5.1	Safety information.	25
5.1.1	General information.	26
5.1.2	Overpressure relief of the grinding bowls.	26
5.1.3	Grinding bowl lid.	28
5.2	Choice of grinding bowls and grinding balls.	29
5.2.1	Size of the grinding balls.	30
5.2.2	Number of balls per grinding bowl (independent of the material quantity).	31
5.2.3	Calculated weight of a ball.	32
5.3	Impact of the ball size and the material during grinding.	32
5.4	Filling quantities of grinding bowls.	33
5.5	Filling the grinding bowl.	34
5.6	Factors with an impact on grinding.	34
5.6.1	Running time (grinding duration).	34
5.6.2	Speed.	34
5.6.3	Reverse mode.	35
5.6.4	Number and size of the balls.	35
5.6.5	Weight of the balls (type of material).	35
5.7	Dry grinding.	35
5.8	Wet grinding (grinding in a suspension).	36
5.8.1	The effect of high temperature.	37
5.8.2	Safety measures against an excessively high pressure.	37
5.9	Handling the grinding bowl.	38
5.9.1	Design.	38
5.9.2	Opening the grinding bowl after a grinding operation.	38
5.9.3	Closing the grinding bowl.	40
5.9.4	Inserting the grinding bowl in the grinding bowl holder.	42
5.9.5	Removing the grinding bowl.	43
5.10	Mass balance.	44
5.11	Grinding duration.	45
5.12	Conducting a grinding operation.	45
5.12.1	Program sequence after switching on.	46
5.12.2	Starting grinding at high speed.	48
5.12.3	Overload.	49
5.12.4	"Program" menu item.	49
5.12.5	Saving the current data.	50
5.12.6	Loading the program.	51
5.12.7	Setting the time control.	51
5.12.8	Imbalance check.	53



5.12.9	Switching off.	54
5.12.10	Cooling the grinding bowl.	54
6	Accessories.	55
6.1	Standard gassing lid for grinding with inert gas.	55
6.1.1	Scope of delivery.	55
6.1.2	Fitting the gassing lid on the grinding bowl.	55
6.1.3	Hose adapter for grinding bowl gassing.	58
6.1.4	Removing the gassing lid in individual steps.	59
6.2	Gassing lid with stainless steel, swagelok hose couplings.	61
6.2.1	Scope of delivery / lid design.	61
6.2.2	Fitting the gassing lid on the grinding bowl.	62
6.2.3	Hose adapter for grinding bowl gassing.	63
6.2.4	Removing the gassing lid in individual steps.	63
6.3	Gas Pressure and Temperature Measuring System.	64
6.3.1	Case contents and system design.	65
6.3.2	Inserting / changing the battery.	65
6.3.3	Configuration of transmitter ID and data transmission frequency.	68
6.3.4	Installation of the transmission unit on the EASY-GTM bowl.	69
6.3.5	Installation of the receiver board in the P-7 premium.	70
6.3.6	Activating EASY-GTM.	71
6.3.7	Entering the temperature limit.	73
6.3.8	Entering the pressure limit.	74
6.3.9	Selecting the operating mode.	75
6.3.10	Deactivating EASY-GTM.	75
6.3.11	Cleaning the EASY-GTM system.	76
6.3.12	Battery arrangement.	77
6.4	Special emptying device for grinding bowls.	78
6.4.1	Design.	78
6.4.2	Handling.	79
6.4.3	Cleaning the special emptying device.	81
6.5	Compl. counterweight.	81
6.5.1	Design.	82
6.5.2	Handling.	82
6.6	Planetary mills - "MillControl" software.	83
6.7	Single-use grinding containers.	84
7	General and optional settings	85
7.1	Standard Operation Procedure.	85
7.1.1	Activating SOP mode.	86
7.1.2	Deactivating SOP mode.	86
7.1.3	Deleting SOP mode.	86

7.2	RFID.....	87
7.3	Language change.....	88
7.4	Screen brightness.....	89
7.5	Information.....	90
7.6	Firmware update.....	90
8	Cleaning.....	92
8.1	Grinding elements.....	92
8.2	Mill.....	92
8.2.1	Removing the grinding chamber cover.....	92
9	Maintenance.....	94
10	Guarantee terms.....	95
11	Exclusion of liability.....	97
12	Safety logbook.....	99



Certification and CE conformity

Certification

Fritsch GmbH has been certified by TÜV Saarland Certification GmbH.



An audit has proven that Fritsch GmbH meets the requirements of DIN EN ISO 9001:2015 and DIN EN ISO 14001:2015.

CE conformity

The enclosed conformity declaration lists the guidelines to which the FRITSCH instrument conforms in order to bear the CE mark.



1 Safety information and use

1.1 Requirements for the user

This operating manual is intended for persons assigned with operating and monitoring the Fritsch the P-7 premium. The operating manual and especially its safety instructions are to be observed by all persons working on or with this device. In addition, the applicable rules and regulations for accident prevention at the installation site are to be observed. Always keep the operating manual at the installation site of the the P-7 premium.

People with health problems or under the influence of medication, drugs, alcohol or exhaustion must not operate this device.

The the P-7 premium may only be operated by authorised persons and serviced or repaired by trained specialists. All commissioning, maintenance and repair work may only be carried out by technically qualified personnel. Qualified personnel are persons who, because of their education, experience and training as well as their knowledge of relevant standards, regulations, accident prevention guidelines and operating conditions, are authorised by those responsible for the safety of the machine to carry out the required work and are able to recognize and avoid possible hazards as defined for skilled workers in IEC 364.

In order to prevent hazards to users, follow the instructions in this manual.

Malfunctions that impair the safety of persons, the the P-7 premium or other material property must be rectified immediately. The following information serves both the personal safety of operating personnel as well as the safety of the products described and any devices connected to them: All maintenance and repair work may only be performed by technically qualified personnel.

This operating manual is not a complete technical description. Only the details required for operation and maintaining usability are described.

Fritsch has prepared and reviewed this operating manual with the greatest care. However, no guarantee is made for its completeness or accuracy.

Subject to technical modifications.



1.2 Scope of application

! NOTICE

Fritsch laboratory mills are not intended for use in explosion-hazardous areas. Fritsch laboratory mills therefore fall outside the scope of the 94/9/EC Directive, but within the scope of the Machinery Directive 2006/42/EC. The use of Fritsch laboratory mills within explosion-hazardous areas is not permissible according to ATEX (94/9/EC) and is only allowed if additional explosion protection measures are taken. According to the Machinery Directive 2006/42/EC, there are no ignition sources in our mills that can become effective during normal operation. Nonetheless, there may be ignition sources in our mills that may become effective in the event of probable malfunctions.

Because Fritsch has only limited information on the composition of the ground product in use, its final fineness and therefore ultimately its ignition temperature, no statement regarding the explosion risk during intended use in conjunction with the occurring energy input can be made.

The occurrence of dust explosions can therefore never be completely ruled out. The user must create an explosion protection document in accordance with the ATEX 137 Directive (1999/92/EC) and define appropriate protective measures.

! NOTICE

This laboratory instrument is designed for an 8-hour shift operation at 30 % duty cycle and not for continuous operation.

The duty cycle is defined as the ratio of load duration to run time. The run time is defined as load duration plus pause time. According to DIN EN 60034-1 (VDE 0530, IEC34-1) a continuous operation already takes place after a standardised run time of 10 minutes. At 30 % duty cycle (DC = ratio of load duration to run time) a load duration of 3 minutes and a pause time of 7 minutes would be within standard.

If the standardised run time of 10 minutes is exceeded, then, by definition, there would be a continuous operation and disproportionate temperature increases may occur, possibly involving increased wear.

The P-7 premium Planetary Mill, can be applied universally for the fast dry or wet grinding of inorganic and organic samples for analysis, quality inspection or material testing.

During synthesis, the Planetary Mill is used for mixing and homogenization of dry samples, emulsions or suspensions.

The P-7 premium described here is an equipment item for use in industrial environments.

The device may be used for these purposes only.

1.2.1 Operating principle

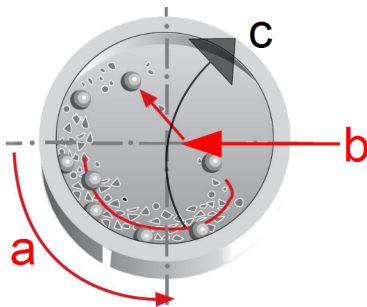

- a Rotation of the grinding bowl
- b Centrifugal force
- c Rotation of the support disc

The source material is crushed and ground by grinding balls in a grinding bowl. The centrifugal forces from the rotation of the grinding bowls around their own axis and from the rotating support disc have an effect on the contents of the grinding bowl, consisting of material to be ground and grinding balls.

The grinding bowl and the support disc have opposite directions of rotation, in order that the centrifugal forces alternate in the same direction and in the opposite direction.

The result is that the grinding balls run down the inside of the bowl's wall with a friction effect and the grinding balls hit the opposite wall of the grinding bowl with an impact effect.

1.2.2 Drive motor and speed regulation

A maintenance-free electric motor operated via frequency converter is used as the drive.

1.3 Obligations of the operator

Before using the the P-7 premium, this manual is to be carefully read and understood. The use of the the P-7 premium requires technical knowledge; only commercial use is permitted.

The operating personnel must be familiar with the content of the operating manual. For this reason, it is very important that these persons actually receive the present operating manual. Ensure that the operating manual is always near the device.

The the P-7 premium may exclusively be used within the scope of applications set down in this manual and within the framework of guidelines put forth in this manual. In case of non-compliance or improper use, the customer assumes full liability for the functional capability of the P-7 premium and for any damage or injury arising from failure to fulfil this obligation.

By using the the P-7 premium the customer agrees with this and recognizes that defects, malfunctions or errors cannot be completely excluded. To prevent risk of damage to persons or property or of other direct or indirect damage, resulting from this or other causes, the customer must implement sufficient and comprehensive safety measures for working with the the P-7 premium.

Neither compliance with this manual nor the conditions and methods used during installation, operation, use and maintenance of the the P-7 premium can be monitored by Fritsch GmbH. Improper execution of the installation can result in property damage and thus endanger persons. Therefore, we assume absolutely no responsibility or liability for loss, damage or costs that result from errors at installation, improper operation or improper use or improper maintenance or are in any way connected to these.

The applicable accident prevention guidelines must be complied with.

Generally applicable legal and other obligatory regulations regarding environmental protection must be observed.



1.4 Information on hazards and symbols used in this manual

Safety information

Safety information in this manual is designated by symbols. Safety information is introduced by keywords that express the extent of the hazard.

 **DANGER**

This symbol and keyword combination points out a directly hazardous situation that can result in death or serious injury if not avoided.

 **WARNING**

This symbol and keyword combination points out a possibly hazardous situation that can result in death or serious injury if not avoided.

 **CAUTION**

This symbol and keyword combination points out a possibly hazardous situation that can result in slight or minor injury if not avoided.

 **NOTICE**

This symbol and keyword combination points out a possibly hazardous situation that can result in property damage if not avoided.

Special safety information

To call attention to specific hazards, the following symbols are used in the safety information:

 **DANGER**



This symbol and keyword combination points out a directly hazardous situation due to electrical current. Ignoring information with this designation will result in serious or fatal injury.

 **DANGER**



This symbol and keyword combination designates contents and instructions for proper use of the machine in explosive areas or with explosive substances. Ignoring information with this designation will result in serious or fatal injury.

 **DANGER**



This symbol and keyword combination designates contents and instructions for proper use of the machine with combustible substances. Ignoring information with this designation will result in serious or fatal injury.



! WARNING

This symbol and keyword combination points out a directly hazardous situation due to movable parts. Ignoring information with this designation can result in hand injuries.



! WARNING

This symbol and keyword combination points out a directly hazardous situation due to hot surfaces. Ignoring information with this designation can result in serious burn injuries due to skin contact with hot surfaces.

Safety information in the procedure instructions

Safety information can refer to specific, individual procedure instructions. Such safety information is embedded in the procedure instructions so that the text can be read without interruption as the procedure is being carried out. The keywords described above are used.

Example:

1. → Loosen screw.

2. →

! CAUTION

Risk of entrapment at the lid.

Close the lid carefully.

3. → Tighten screw.



Tips and recommendations



This symbol emphasises useful tips and recommendations as well as information for efficient operation without malfunction.

Further designations

To emphasise procedure instructions, results, lists, references and other elements, the following designations are used in this manual:

Designation	Explanation
 1., 2., 3. ...	Step-by-step procedure instructions
⇒	Results of steps in the procedure
	References to sections in this manual and relevant documentation



Designation	Explanation
■	Lists without a specific order
[Button]	Operating elements (e.g. push button, switch), display elements (e.g. signal lamps)
'Display'	Screen elements (e.g. buttons, function key assignment)

1.5 Information on hazards at the device

There is a laser radiation hazard warning on the back of the device.

It is explained below.

Do not remove the information and warning signs.

Caution! Hot surface



Caution! Crushing hazard



1.6 Device safety information

- Only use genuine accessories and genuine spare parts. Failure to observe this instruction can compromise the safety of the machine.
- Accident-proof conduct is to be strictly followed during all work.

 **DANGER**



Explosion hazard!

- Wear safety goggles. The high temperature or chemical reactions during the grinding process may result in overpressure in the grinding bowl. Splashing hazard! Explosion hazard! Do not fail to observe → *Chapter 5.1 'Safety information' on page 25* and → *Chapter 5.8.2 'Safety measures against an excessively high pressure' on page 37*.
- Never use brute force to open the grinding bowl. Open the grinding bowl only if you are sure that the internal pressure has been released completely. Observe the opening instructions in → *Chapter 5.9.2 'Opening the grinding bowl after a grinding operation' on page 38* and → *Chapter 5.8.2 'Safety measures against an excessively high pressure' on page 37*.
- The device may only be operated indoors. The surrounding air must not contain any electrically conductive dust.
- When grinding oxidisable substances (e.g. metal or coal), there is a risk of spontaneous combustion (dust explosion) if the proportion of fine particles exceeds a certain percentage. Chemical reactions are also possible during wet grinding. When grinding these kinds of substances, special safety measures (e.g. wet grinding) must be taken and the work must be supervised by a specialist.
- The device is not explosion-protected and is not suitable for grinding explosive materials.

 **DANGER**

- Do not reuse damaged accessories.
- If the planetary micro mill or its components are damaged or if its operation is not as described in the operating manual, the device may not be put into service. In such a case, consult your Fritsch GmbH representative or distributor.

 **WARNING**

The maximum accepted concentration (MAC) levels of the valid safety regulations must be observed. If necessary, ventilation must be provided or the machine must be operated under an extractor hood.



CAUTION

- Wear hearing protection! Above a sound level of 90dB(A)
- Wear safety gloves! The grinding bowls may get very hot. See → Chapter 1.8 'Hazardous points' on page 15, → Chapter 5.8.1 'The effect of high temperature' on page 37 and → Chapter 5.12.10 'Cooling the grinding bowl' on page 54.
- Do not grind with the device for several hours in succession without cooling phases. Risk of overheating!
- The device may not be run without supervision. In certain operating states, the vibrations may result in a shifting effect on the surface.

- Do not remove the information signs.
- Unauthorised alteration of the device will void Fritsch's declaration of conformity to European directives and void the guarantee.
- If, after reading the operating manual, there are still questions or problems, please do not hesitate to contact our specialists.

1.7 Protective equipment



Protective equipment is to be used as intended and may not be disabled or removed.

All protective equipment is to be regularly checked for integrity and proper functioning.

DANGER

- The valves on the grinding bowls may not be repaired.
- Each time before using the planetary micro mill, check that the protective equipment is not damaged or contaminated (see → Chapter 1.8 'Hazardous points' on page 15, → Chapter 1.9.1 'Electrical safety' on page 15 and → Chapter 5.1 'Safety information' on page 25).
- Do not make any changes to the protective equipment, apart from the maintenance tasks listed in the operating manual.
- The device's grinding chamber cover can only be opened and closed by a motor and therefore not without a connection to the power supply. See → Chapter 1.9.2 'Protection against restart' on page 15.
- It can only be opened when the mill comes to a stop.
- The grinding chamber cover must always be closed during grinding.
- When the grinding chamber cover is open, the mill's mechanical unit is locked mechanically to prevent it from starting.

1.8 Hazardous points

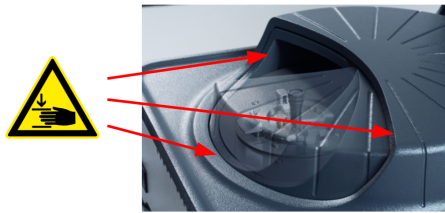

- Crushing hazard when opening and closing the grinding chamber cover (the closing force can be adjusted, consult Fritsch GmbH).



- Crushing hazard when adjusting the control display.

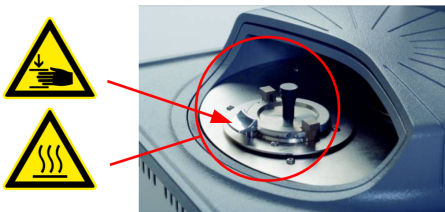

- Crushing hazard when using the locking lever.

CAUTION

Fire hazard at the grinding bowl after grinding and during the grinding pauses. See → Chapter 5.3 'Impact of the ball size and the material during grinding' on page 32, → Chapter 5.8.1 'The effect of high temperature' on page 37 and → Chapter 5.12.10 'Cooling the grinding bowl' on page 54.

DANGER



The grinding bowl may open extremely suddenly if the internal pressure is too high. Never use brute force to open the bowl. Do not fail to observe → Chapter 5.8.1 'The effect of high temperature' on page 37 and → Chapter 5.8.2 'Safety measures against an excessively high pressure' on page 37.

1.9 Electrical safety

1.9.1 General information

- The main switch separates the device from the power supply with two poles.
- Turn off the main switch if the planetary micro mill is "out of service" for prolonged periods (e.g. overnight).

1.9.2 Protection against restart

In the case of a power failure during operation or after turning the device off at the main switch, the grinding chamber cover is locked. When the power supply is restored, the grinding chamber is not opened until the software detects that the drive is stationary. For safety reasons, however, the planetary micro mill does not restart.



1.9.3 Overload protection

- In the event of an overload, the device reduces the speed in a controlled manner. This special operating state is indicated on the display.
- The device shuts down if the drive motor becomes too hot.
- The device shuts down if the drive is blocked.

1.9.4 Imbalance detection

The device shuts down if there is excessive imbalance. See [Chapter 5.1 'Using the device'](#) on page 25.

2 Technical data

2.1 Dimensions

360 mm x 400 mm x 580 mm
(height x width x depth)

2.2 Weight

Net: approx. 44 kg
Gross: approx. 61 kg

2.3 Operating noise

The sound level is approx. 74 dB (A). This value fluctuates significantly, depending on the speed and material to be ground and on the type of grinding bowl and grinding balls.

The device is rated with IP 20.

2.4 Voltage

The device can be operated in two voltage ranges:

- Wide range input 100-240 V \pm 10 %.

Transient overvoltage according to overvoltage category II permitted.



If the device is to be operated with two different voltages, e.g. 115 V or 230 V, it must be disconnected from the power supply at least 60 seconds before switching over the voltage.

2.5 Current consumption

The maximum current consumption is approx. 10 A (115 V)
or 5 A (230 V).

2.6 Protection class

IP 21

2.7 Power consumption

The maximum power consumption is approx. 1100 W.

2.8 Electrical fuses

- Fuses on the back of device: 2x10 A T



2.9 Material

- Maximum feed amount in the case of hard material approx. 5 mm
- Maximum feed 1 - 60 ml

2.10 Final fineness

- Dry grinding < 20 μm (depending on materials and parameters)
- Wet grinding < 0,05 μm (depending on materials and parameters)

3 Installation

3.1 Transport

The device is delivered on a transport pallet with a wooden cover. We recommend using a forklift or pallet truck for transporting the packed device.



⚠ DANGER

Do not step under the transport pallet during transport.

⚠ WARNING

Improper lifting can lead to personal injury or property damage. The machine is only to be lifted with suitable equipment and by qualified personnel.

The guarantee excludes all claims for damage due to improper transport.

3.2 Unpacking

- Open the straps of the packaging.
- Remove the lid from the crate or open the crate upwards.
- Remove the accessory cardboard pieces and additional padding.
- Lift the upper part of the packaging off the transport pallet.
- The device can now be lifted off the pallet and out of the foam padding.

⚠ CAUTION

Crushing hazard!

Always lift with 2 persons.

Hold the bottom edge of the housing when lifting.

- Compare the contents of the delivery with your order.



Grinding bowls made of hardened steel may have recesses on the surface caused during production. They do not have an impact on grinding or the grinding results and usually disappear after the first grinding operation.

These recesses on the surface, if present, are within the range of the permissible production tolerances. Complaints relating to such grinding bowls therefore cannot be accepted.



3.3 Setting up

NOTICE

Allow the device to acclimatise for two hours before commissioning. High temperature differences can lead to condensation in the device and damage to the electronics after switching on.

Strong temperature fluctuations can occur during transport or interim storage. Depending on the temperature difference between the installation site and the transport or storage environment, condensation can form inside the device. This can damage the electronics if the devices are switched on too early. Wait for at least two hours after setup before switching on the device.

- Set up the planetary micro mill indoors, on a flat and firm surface.

NOTICE

Never operate the P-7 premium while it is standing on the transport pallet!

- Make sure that:
 - all switches / control elements are easy to access;
 - the ventilation slots are not covered;
 - the interfaces (USB / Ethernet) are easy to access.

CAUTION

Risk of overheating!

The cover on the housing openings may reduce the supply of air, thus causing the device to overheat.

- Please store the transport packaging in order that it can be reused in case you need to return the product. Fritsch GmbH denies all liability for any damage due to improper packaging (non-genuine packaging).

3.4 Ambient conditions

WARNING

Mains voltage!



- The device may only be operated indoors.
- The surrounding air may not carry any electrically conductive dust.
- Maximum relative humidity 80% for temperatures up to 31°C, linearly decreasing down to 50% relative humidity at 40°C.

- The room temperature has to stay between 5 - 40°C.
- Altitudes up to 2000 m
- Degree of pollution 2 according to IEC 664.

3.5 Electrical connection

 **DANGER**

 **Provide short-circuit protection!**

Risk of damage due to short-circuits.

- Make sure that the socket is connected to a mains line protected with a residual current circuit breaker.

Before establishing the connection, compare the voltage and current values stated on the type plate with the values of the power supply system to be used.

 **DANGER**

Mains voltage!

Changes to the connection line may only be made by a qualified person.

 **CAUTION**

Ignoring the values on the type plate may result in damage to the electrical and mechanical components.

 **NOTICE**

Fritsch mills are speed controlled. The devices are equipped for this with frequency converters. In order to comply with the EMC directive, many measures must be taken to prevent operational transient emissions.

The possible leakage currents resulting from filtering measures can trigger a conventional residual current circuit breaker in the mains line. **This is no defect!**

To prevent this, special residual current circuit breakers, which are adapted for operation with frequency converters, are commercially available.

Operation without a residual current switch is possible, but must be done in accordance with the relevant regulations.



4 Initial start-up

Switch on the device only after all work as described in → Chapter 3.1 'Installation' on page 19 has been carried out.

4.1 Switching on

1. → Connect the device to the power supply using the cable provided (device cable with IEC 320/C13 plug).
2. → Turn the device on at the main switch.
3. → The display lights up.



4.2 Function check

1. → Grinding station 1 is moved into the loading position.
2. → The grinding chamber cover opens.
3. → Check if grinding station 1 is empty (no bowl inserted).
4. → Press BUTTON "2" on the display.
5. → Grinding station 2 is moved into the loading position.
6. → Check if grinding station 2 is empty.

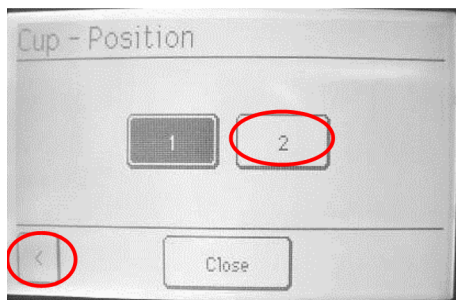

7. → Press the "<" button for confirmation and to access the main menu.
8. → Press the "Menu" button.

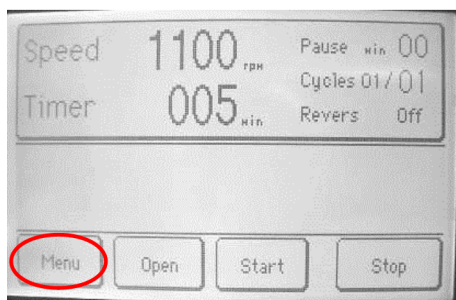

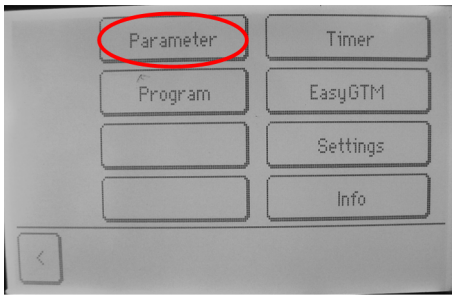

9. You can make various settings in the next menu. Select the "Parameters" menu item.

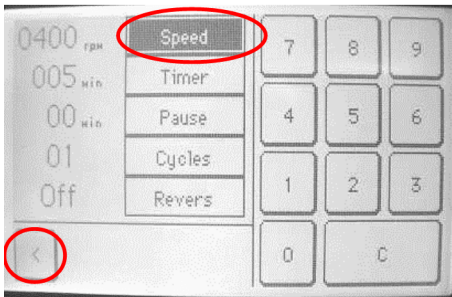

10. A sub-menu appears in which you can enter the speed using the input keys. Set the speed to 150.

11. Press the "<" button to save your entry and return to the main menu.

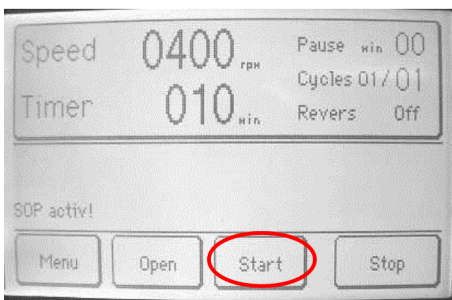

12. Press the "Start" button to close the grinding chamber cover and start the safety check.

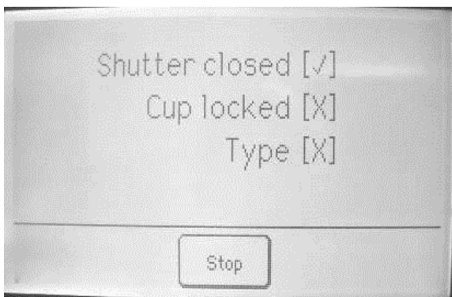

13. Various sensors check the bowls and the closing mechanism. That will take a few moments.

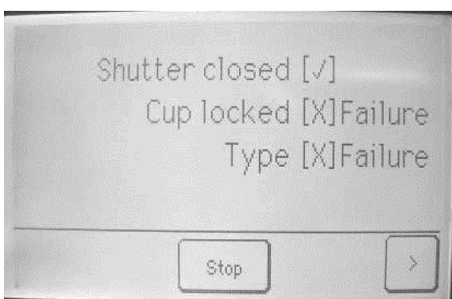

14. The sensors detect that the grinding bowls are not present.

15. Press the ">" button to open the grinding chamber cover and grinding station 1 is moved into the loading position.

16. The device functions are OK.



4.3 Switching off

If the device is put out of service for a lengthy period, close the grinding chamber cover using the "Close" button and turn the device off at the main switch.

5 Using the device

5.1 Safety information

 **DANGER**

The P-7 premium Planetary Mill from Fritsch enables speeds of up to 1100 rpm. The application of high energy may result in very high temperatures and high pressures in the grinding bowl.

Failure to observe the following safety instructions could result in the explosion of grinding bowls and parts flying around, causing injuries and damage to the building or device.

We cannot accept any liability for the occurrence and consequences of injuries or damage to the building or device resulting from a reaction of the sample material in the grinding bowl that cannot be anticipated or controlled.

Bear in mind that it is essential that test grinding operations with unknown parameters are always carried out in a safe room that reliably prevents damage by exploding grinding elements.

 **WARNING**

Make sure before starting the machine that the grinding bowls have been tensioned correctly and that there are no loose parts inside the device. There is a risk of loose grinding bowls or parts being flung out. Failure to observe this will void the guarantee and release us from liability for any resulting damage to the device or personal injury.

 **NOTICE**

During grinding, the temperatures in the grinding bowl may get very high.

In encased grinding bowls, the inserts are glued into the casing with a two-component construction adhesive.

The adhesive is resistant to temperatures up to approx. 140 °C. Above 140 °C, the adhesive will liquefy and accumulate below the insert in the casing. When the adhesive cools down, it solidifies and pushes the casing up. That can cause irreparable damage to the insert. The grinding bowl will definitely be rendered unusable.

Above temperatures of 200 °C, the adhesive will be destroyed. The same applies for encased grinding bowl lids.

 **NOTICE**

The planetary drive is provided by the main disc via a toothed belt drive. Constant high loads stress the toothed belt severely, and may even damage it. High loads may be: heavy loads, high speeds, high temperatures, long operating times or combinations of these.

 **NOTICE**

The grinding duration in the reversing mode must not exceed 5 minutes. A longer grinding duration in the reversing mode may damage the P-7 premium.



! NOTICE

If the permissible maximum temperature in the bowl is exceeded during grinding, then the device must not be switched off with the lid closed. That could lead to heat accumulation in the machine, which could cause damage to the device.

Provide sufficient cooling by letting the mill continue to run at a speed of 150 rpm for approx. 20 - 30 min. or by shutting off the mill with the lid open.

5.1.1 General information

The grinding bowls have been tested and approved exclusively for slowly rising (static) internal pressures up to 20 bar.

If the pressure increases gradually, safety elements in the lid prevent the build-up of an unacceptable overpressure.

The grinding bowl lids seal the grinding chamber gas-tight up to 20 bar after manual pre-tensioning. The locking mechanism is designed with a safety factor. This structural strength does not constitute approval or safety against dynamic pressure events > 20 bar.

In such a case, the grinding bowls and the machine are not covered by the Fritsch guarantee.

To clean the grinding bowl and its components, follow the operating instructions precisely (→ *Chapter 8.1 'Cleaning' on page 92*).

5.1.2 Overpressure relief of the grinding bowls

The seals in the grinding chamber act both as seals and as pressure relief valves. When the pressure increases slowly during the grinding process, the seals open at a defined pressure of approx. 20 bar and allow the excess pressure to escape in a controlled manner.

DANGER

The pressure relief system is not effective in the event of rapid pressure increases (e.g. explosions, very fast chemical reactions). In such cases, the behaviour of the grinding bowl system cannot be controlled, as these loads are outside the intended operating conditions. This does not constitute a defect or quality flaw. The operator is obliged to assess their applications with regard to possible dynamic pressure events and to take appropriate measures to prevent them.

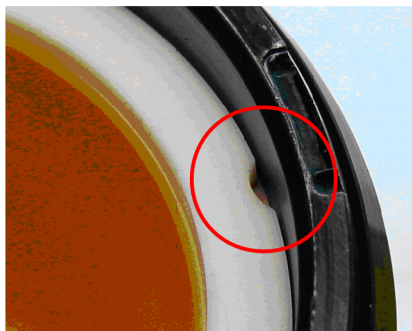

A half-round notch with a diameter of 2 mm is punched onto the outer diameter of the flat seal. The grinding bowl's pressure release works with flat seals made of fluororubber above a static internal grinding bowl pressure of about 10 bar. Flat seals made of silicone open above a static internal grinding bowl pressure of about 18 bar.

⚠ DANGER

If flat seals are used without this defined notch, very high pressures will develop in the grinding bowl that could cause it to burst (resulting in damage and injuries).

The application of high energy during grinding results in high temperatures in the grinding bowl. An 80 ml grinding bowl filled with 60 ml water results in the development of the following pressures and temperatures:

Temperature of grinding bowl wall [°C]	Pressure in the grinding bowl [bar]
101	1
109	2
127	4
141	6
152	8
159	10
166	12
171	14
177	17
180	19
183	21

If water is used as an additive, the overpressure release with fluororubber flat seals is triggered at 159 °C, and with silicone flat seals at 180 °C. Any effects by the ground material are not taken into account.

Be extremely careful if solvents are used. 60 ml isopropanol in an 80 ml grinding bowl results in the development of the following pressure and temperature:

Temperature of grinding bowl wall [°C]	Pressure in the grinding bowl [bar]
50	1
73	2
86	5
109	8



Temperature of grinding bowl wall [°C]	Pressure in the grinding bowl [bar]
124	10.5
132	13
139	14
148	19
149	20

The overpressure limit for fluororubber flat seals is reached at 120 °C and for silicone seals at 149 °C.

Here is an example of the pressure and temperature development during an actual grinding operation:

Grinding balls: 120 g 0.4-0.7 mm ZrO₂

Grinding bowl: 80 ml ZrO₂

Material to be ground: 10 g aluminium oxide with feed size d₅₀=20 µm

Addition: 30 ml water

Speed: 1100 rpm

Time [min]	Bowl 1 [°C]	Bowl 2 [°C]
10	124	119
15	140	136

Other configurations or material to be ground may result in high temperatures being reached much sooner.





Because the gases and solids are mixed completely in the grinding bowl, pure gas is never discharged. Material to be ground is also discharged. To clean the mills, see → Chapter 8.1 'Cleaning' on page 92.

5.1.3 Grinding bowl lid

The grinding chamber lids seal the grinding chamber gas-tight up to 20 bar after manual pre-tensioning (see also → Chapter 5.8.2 'Safety measures against an excessively high pressure' on page 37). The locking mechanism is designed with a safety factor. This structural strength does not constitute approval or safety against dynamic pressure events > 20 bar.

In the event of sudden internal pressure build-up, proper use is not guaranteed from the manufacturer's point of view in terms of risk analysis and is subject without exception to the operator's duty of care.

 **DANGER**

 **Danger to life!**

An explosion in the grinding bowl may cause severe injuries and damage to the device.

In the context of our product monitoring, we would like to inform you about the following damage cases that have occurred:

- During dry grinding of a light alloy/resin mixture, there was a severe explosion of the grinding bowl after 64 cycles (5 min. grinding + 10 min. pause; 800 rpm) that completely destroyed the device.
- During wet grinding of silicone powder in DEGBE (solvent), there was an explosion in the grinding bowl exploded after 11 cycles (10 min. grinding + 30 min. pause) that ripped off the locking hooks of the grinding bowl lid. The grinding bowl lid caused irreparable damage to the mill hood and the safety blocking mechanism stopped the mill.
- During dry grinding of a silicon compound, in grinding conditions not known to us and not disclosed by the customer, there was an explosion of the grinding bowl that ripped the locking hooks off the grinding bowl lid.

5.2 Choice of grinding bowls and grinding balls

 **CAUTION**

If the grinding elements used are not genuine accessories, we assume no guarantee and exclude all liability for damage to the device or for personal injury.

 **CAUTION**

The grinding element is subject to normal wear when used. Before every grinding operation, check the wall thickness of the grinding bowls. In the event of severe wear, replace the grinding bowl. If this is not done, the prevailing high centrifugal forces during grinding may cause the grinding balls to penetrate the bowl's wall and damage the mill. Failure to observe this will render void the guarantee and release us from liability for any resulting damage to the device or personal injury.

 **NOTICE**

Each grinding process means wear to the grinding element. Therefore, please pay attention to what components the material of the grinding element contains and whether these could react with the sample. Such reactions may have consequences. A simple reaction with minor consequences may be, for example, the grinding of samples containing sulphur in the steel bowl, which contains iron. The iron released by abrasion can combine with sulphur and react to form iron sulphide. This can lead to black deposits on your grinding set.

The hardness and density (specific weight) of the grinding bowl and grinding balls used have to be greater than that of the material used to prevent excessive wear by abrasion.



Material (bowl and balls)	Main components of the material	Density in g/cm ³ High density means high impact energy!	Abrasion resistance	Use for grinding stock
Agate	(99.9% SiO ₂)	2.65	Good	Soft to medium-hard samples
Silicon nitride	(90% Si ₃ N ₄)	3.25	Extremely good	Abrasive samples, metal-free grinding
Sintered corundum	(99.7% Al ₂ O ₃)	3.9	Fairly good	Medium-hard, fibrous samples
Zirconium oxide	(96.2% ZrO ₂)	5.7	Very good	Fibrous, abrasive samples
Hardened, stainless steel	(16.0 - 18.0% Cr)	7.7	Fairly good	Medium-hard, brittle samples
Tungsten carbide	(93% WC + 6% Co)	14.9	Very good	Hard, abrasive samples

The grinding bowls and grinding balls made of zirconium oxide are resistant to acids - apart from hydrofluoric acid.

Normally choose a grinding bowl and grinding balls that are made of the same material.

Exception: Tungsten carbide balls (<20 mm) may be temporarily (a few minutes) combined with grinding bowls made of hardened steel.

5.2.1 Size of the grinding balls

Type of feed material	Suitable ball diameter
Hard samples with a maximum feed size of 5 mm	15 mm / 20 mm
Average feed size of 0.5 – 1 mm	15 mm / 10 mm
Fine material 0.1 – 0.5 mm	10 mm or smaller
Very fine material < 0.1 mm	3 mm and smaller
Homogenisation of dry or liquid samples	10 mm or smaller

! NOTICE

It is not advisable to mix balls of different diameters. (If balls with different diameters are used, increased wear to the balls is to be expected.)

5.2.2 Number of balls per grinding bowl (independent of the material quantity)

A higher number of balls will reduce the grinding duration and the grinding results will be within a smaller grain size range.

The number of balls should be complied with to avoid unnecessary wear.

Ball diameter (mm)	Grinding bowl volume (ml)	20	45	80
20	Number of balls (pcs)	-	-	5
15	Number of balls (pcs)	-	7	10
10	Number of balls (pcs)	10	18	25
5	Number of balls (pcs)	80	180	250

Ball with a diameter of 3 mm and smaller

Material	Grinding bowl volume (ml)	20	45	80
Zirconium oxide	Amount of balls (grams)	30	70	100
Hardened, stainless steel	Amount of balls (grams)	40	90	150
Tungsten carbide	Amount of balls (grams)	80	200	300



5.2.3 Calculated weight of a ball

Ball diameter in mm		5	10	15	20
Material	Density in g/cm ³	Calculated weight of a ball in g			
Agate	2,65	0,17	1,39	4,68	11,1
Silicon nitride	3,25	0,20	1,16	5,48	12,99
Sintered corundum	3,9	0,25	1,99	6,72	15,92
Zirconium oxide	5,7	0,37	2,98	10,07	23,88
Hardened, stainless steel	7,7	0,50	4,03	13,60	32,25
Tungsten carbide	14,9	0,96	7,40	25,98	61,58

To determine the weight of the required balls, the "calculated weight of a ball" is multiplied with the "amount" of balls required.

Example: A 45 ml agate bowl is to be filled with 180 agate balls with a diameter of 5 mm.

Calculation: $0.17 \text{ g} \times 180 \text{ St} = 30.6 \text{ g}$

30,6 g grinding balls can be weighed and inserted in the grinding bowl, thus avoiding the time required for counting the balls.

5.3 Impact of the ball size and the material during grinding

Large balls with a diameter of 10 mm – 20 mm will result in high mechanical system stress. The combination of the heavy weight of the balls and high acceleration result in high mechanical stress → **impact effect**.



The higher the density of the material to be ground, the higher the mechanical stress is.

The highest mechanical stress is achieved with balls made of tungsten carbide with a diameter of 20mm.

If large agate balls are used, they could destroy themselves and the grinding bowls.

That is also the case with sintered corundum and silicon nitride balls.

Balls with a diameter of 5 mm and less result in high thermal system stress.

The large surface of many small balls results in high thermal stress due to the friction effect. It can already be measured after 5 minutes of grinding above 100 °C by a **surface sensor** on the surface of the lid. Inside the grinding bowl, the temperature is then much higher.



The adhesive used is permanently resistant to temperatures of up to 140 °C. If the external temperature does not exceed 100 °C, the adhesive will hold.

5.4 Filling quantities of grinding bowls

CAUTION

For wet grinding with large balls with a diameter of >10 mm, at least half the maximum sample quantity must be inserted. If the suspension is highly fluid, the balls will not have any resistance and the balls and the grinding bowl could be damaged. The result is the same as if it had been filled with no grinding stock. The same applies to dry grinding with less than the minimum sample quantity.

NOTICE

Never operate the mill without grinding stock! This can lead to grinding balls and grinding bowls getting damaged.

NOTICE

If the minimum filling quantity is fallen short of, increased wear due to abrasion is to be expected. This can cause irreparable damage to the mill components.

NOTICE

The filled in volume can increase during the grinding. Check the volume after a brief grinding time.

Grinding bowl	Min. sample quantity	Max. sample quantity
20 ml	1 ml	9 ml
45 ml	3 ml	20 ml
80 ml	10 ml	35 ml



5.5 Filling the grinding bowl

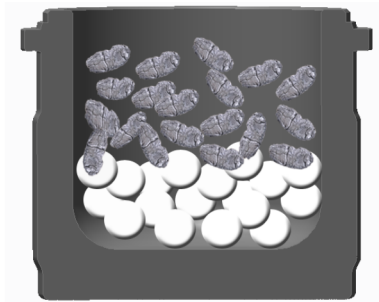

CAUTION



Do not fill in any dry ice or liquid nitrogen in the grinding bowls!

Adding dry ice or liquid nitrogen into the grinding bowls can lead to a sudden increase in volume with a high static pressure. This can result in an explosion of the grinding bowls.

Do not fail to comply with the following sequence:

1. → Place the grinding balls in the empty bowl.
2. → Fill grinding stock onto the balls.

NOTICE

Make sure the sealing surface is clean and the seal is not damaged.

3. → Place the lid on the grinding bowl.

5.6 Factors with an impact on grinding

5.6.1 Running time (grinding duration)

To reduce the grinding time, you can use a grinding bowl and grinding balls with a higher density, and thus a higher impact energy.

5.6.2 Speed

Higher speeds shorten the grinding time and increase the percentage of fine particles.

Lower speeds increase the grinding time and lower the temperature, which can lead to fewer pauses. This means that the overall working time may remain the same. The wear is increased in this case though.



Fritsch recommends however to use the maximum speed and to plan for enough pauses so that the wear is minimised.



For thermally sensitive materials, the optimal rotational speed needs to be determined through experimentation.

5.6.3 Reverse mode

! NOTICE

The grinding duration in the reversing mode must not exceed 5 minutes. A longer grinding duration in the reversing mode may damage the P-7 premium.

Useful for mechanical alloying.

Improvement of the homogeneity of the sample.

The grinding duration of a grinding cycle in reversing mode must not exceed 5 minutes. The overall duration is determined by the number of cycles.

Overall grinding duration = time x cycles

5.6.4 Number and size of the balls

! NOTICE

It is not advisable to mix balls of different diameters. If balls with different diameters are used, increased wear and damage to the grinding elements is to be expected.



You can find the recommended number and size of balls in [Chapter 5.2 'Choice of grinding bowls and grinding balls'](#) on page 29.

Larger balls are used for pre-crushing. (See [Chapter 5.2.2 'Number of balls per grinding bowl \(independent of the material quantity\)'](#) on page 31).

To increase the proportion of fine particles, the large balls need to be replaced by smaller ball sizes during the course of the grinding process.

5.6.5 Weight of the balls (type of material)

A higher mass (specific weight) of the grinding balls accelerates grinding. (see table in [Chapter 5.2 'Choice of grinding bowls and grinding balls'](#) on page 29).

5.7 Dry grinding

! DANGER



Staubexplosion!

There is a risk for very fine powder dust of a dust explosion. Particularly fine (pure) metals can ignite spontaneously. Mind the external temperature and the pressure that can develop in the grinding bowl during the dry grinding.



! NOTICE

Dry grindings need to be checked in briefer intervals. Longer dry grindings, without pauses and checks, can cause the grinding set to gum up and to become damaged. In particular with agate, the grinding bowl and grinding balls can become damaged after a short grinding time.

At a particle size of less than 20 µm, the surface forces prevail. The grinding stock begins to stick.

Additional dry comminution can be achieved by adding surface-active substances to the material to be ground.

Examples (maximum amount to be added in mass %)

- Stearic acid 2-3 %
- Aerosil (fine-particle silicic acid) 0.5 - 2 %
- Quartz sand ~ 2 %
- Glass powder ~ 2 %
- Glycol (Ethylene glycol) ~ 0.1 - 0.5 % (Δ 5 - 25 droplets)
- Triethanolamine ~ 0.1 - 0.5 %

5.8 Wet grinding (grinding in a suspension)

DANGER



Explosion hazard! Ignition hazard!

The device is not explosion-protected. If flammable liquids are used, make sure that the heat developing in the grinding bowl does not reach the solvent's boiling point. Program appropriate cooling phases. If the vapour pressure is too high, vapours may escape and ignite.

If it can be avoided, we recommend using non-flammable liquids or liquids with a high boiling point. The boiling point should be above 80 °C and above 100 °C for a long grinding duration.

During the transition to grinding in suspension, you can add a liquid auxiliary agent with high boiling point and low vapour pressure, e.g. water, white spirits (boiling point 100 - 140°C), or alcohols with a high boiling point (e.g. isopropanol)

We recommend that you only use so much liquid that the suspension has the same consistency as motor oil. With this viscosity the best results can be achieved in most cases.

5.8.1 The effect of high temperature

 **DANGER**

During wet grinding in the grinding bowls, the high internal temperature, the increase in size of the surface of the particles due to crushing and any chemical reactions in the bowl may result in the development of a very high pressure.

This pressure can get so high that the hooks that hold the lid on the bowl crack, resulting in the lid "flying off". During grinding tests, chemical reactions of steel parts (hardened steel and stainless steel) and tungsten carbide parts with water suspension were determined. After a grinding period of 20 minutes, the increase in pressure could tear off the locking hooks. The grinding bowl temperature may be relatively low.

 **DANGER**



Explosion hazard! Ignition hazard! Burn hazard!

In the event of a longer grinding duration, apply cooling pauses to reduce the internal pressure. For certain material to be ground, it may also be necessary to release the pressure after the cooling phase, otherwise it could be retained in the bowl in spite of cooling. That is in particular also the case in the event of a chemical reaction in the grinding bowl. See → Chapter 5.3 'Impact of the ball size and the material during grinding' on page 32, → Chapter 5.8.2 'Safety measures against an excessively high pressure' on page 37 and → Chapter 5.12.10 'Cooling the grinding bowl' on page 54.

 **NOTICE**

If the permissible maximum temperature in the bowl is exceeded during grinding, then the device must not be switched off with the lid closed. That could lead to heat accumulation in the machine, which could cause damage to the device.

Provide sufficient cooling by letting the mill continue to run at a speed of 150 rpm for approx. 20 - 30 min. or by shutting off the mill with the lid open.

The bowl may get stuck on the holder if the bowl temperature gets too high. In such a case, wait until the bowl has cooled down sufficiently in order that it is released by the holder.

5.8.2 Safety measures against an excessively high pressure

Safety measures against an excessively high pressure



1 Recess

To prevent damage to the grinding bowls and the device, the flat seal has a small recess on its external diameter. The pressure may be released at this point if the insert is lifted by the internal pressure in the bowl. That is the case with an internal pressure of about 20 bar.

Use genuine seals only.



WARNING

Never use brute force to open the bowl

5.9 Handling the grinding bowl

5.9.1 Design



Grinding bowls made of agate have a second actuating screw (8) mounted instead of the valve plug (6) and the press-on sleeve (7). Thus, when opening the grinding bowls made of agate, you can start directly with step 3 in the following chapter.



- 1 Compl. bowl
- 2 Compl. lid
- 3 Flat seal
- 4 Locking hook
- 5 Compl. handle
- 6 Valve plug
- 7 Press-on sleeve
- 8 Actuating screw
- 9 Lid insert

5.9.2 Opening the grinding bowl after a grinding operation

1. → Allow the bowl (1) to cool down.

Using the device



- 2.** → Release the pressure by turning the press-on sleeve (7) to open it.

! NOTICE

After releasing the pressure via the press-on sleeve, this and the valve plugs (6) must be cleaned thoroughly before further grinding processes. If this is not done, the tightness may be reduced due to residual sample material.

After restarting and reaching the set speed, we recommend securing the press-on sleeve (7) and handle (5) again.

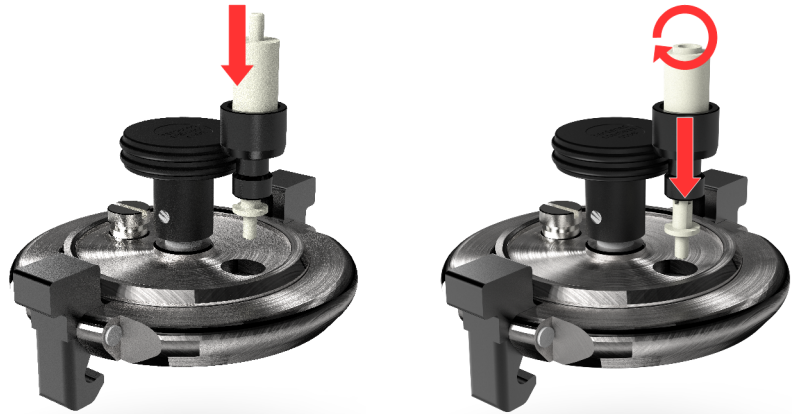

- 3.** → Turn the handle (5) to open it.



- 4.** → If the lid insert (9) is sticking on the flat seal (3), apply a screwdriver to the actuating screw (8) to remove the lid insert (9) from the flat seal (3).



- 5.** → Open the lid (2).





5.9.3 Closing the grinding bowl



Attention!

1. → Insert the flat seal (3) in such a way that the recess is near a locking hook (4).



2. → Push the locking hooks (4) inwards completely at the top end and place the lid (2) on the bowl (1).

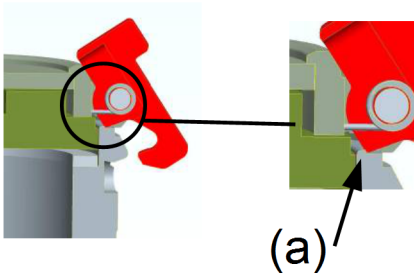

(a) Lug

3. → The lid (2) is now lying on the small lug (a) of the locking hook (4) on the edge of the bowl.



4. → Turn the lid (2) on the bowl until the small lugs (a) of the locking hooks (4) engage in the recesses on the edge of the bowl.

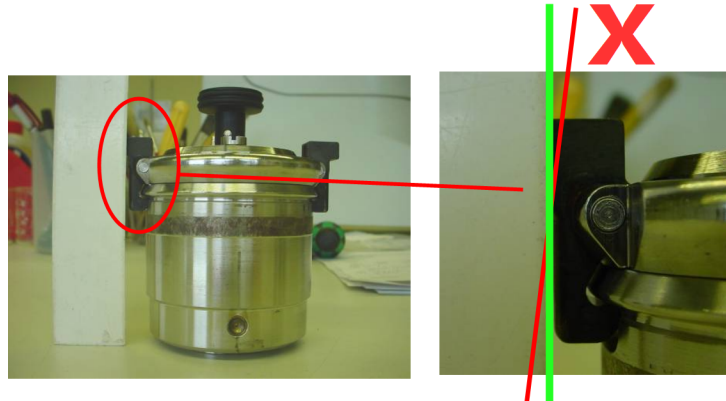

5. → Release the locking hooks (4) and push them together at the bottom end until they engage and are exactly vertical.
6. → Make sure that the locking hooks engage exactly in the middle of the recess. Only then can the bowl be closed properly and inserted in the device.
⚠ Make sure that the distances are the same.

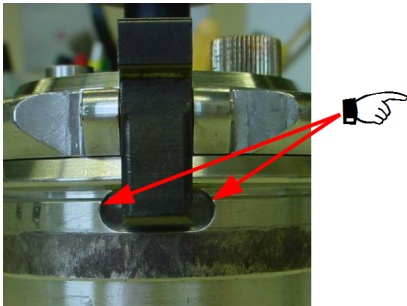

7. → Turn the handle (5) down firmly; the press-on sleeve (7) must be released for air to escape from the bowl.



8. → Turn the press-on sleeve (7) down firmly.



! NOTICE

Once the locking hooks are engaged, the lid may no longer be turned against the bowl. The positions of the hooks and grooves in the bowl below the hooks must match



5.9.4 Inserting the grinding bowl in the grinding bowl holder

Carry out the following checks before inserting the grinding bowls:

1. → Are the grinding bowls clean on the outside? → remove any coarse dirt.
2. → Is the grinding bowl adapter clean on the inside? → remove any coarse dirt.
3. → Are the grinding bowls sealed correctly (see → Chapter 5.1 'Using the device' on page 25).

Inserting the grinding bowls

- 10 Clamping bracket
- 11 Locking element
- 12 Bracket guide

1. → Open the clamping bracket (10).

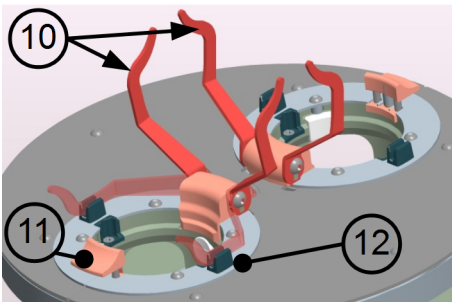

2. → Hold the grinding bowl at the handle (5) and set it in the grinding bowl adapter.

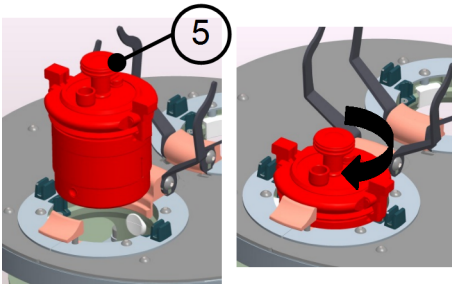

3. → Turn the grinding bowl until it can be felt to engage and drops a few millimetres into the grinding bowl adapter.

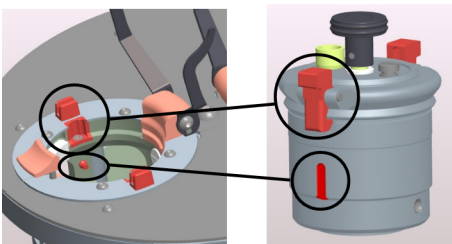

4. → Push the locking element (11) down on the bowl holder. → the grinding bowl is lowered within the mounting device.

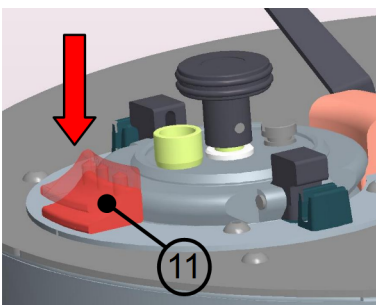

Using the device

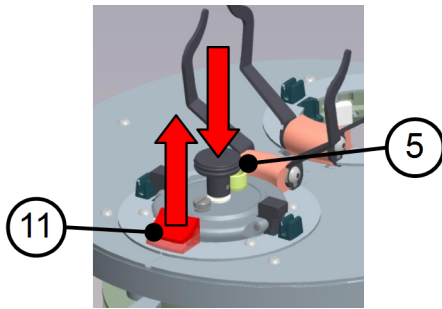

5. → Apply vertical pressure to the grinding bowl handle (5) to lock the grinding bowl in place in its adapter. The grinding bowl is locked correctly if the locking element (11) on the mounting device moves back up into its initial position.

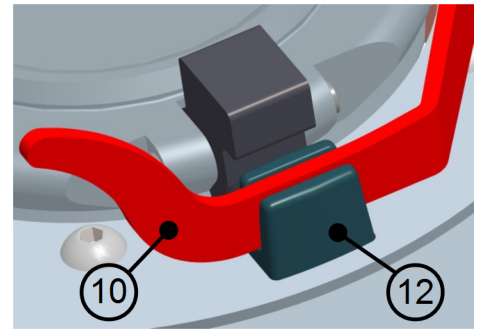
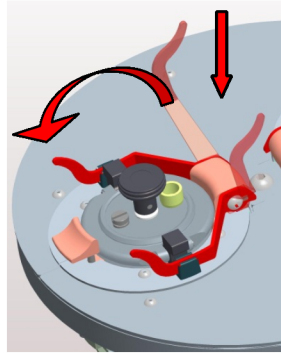

6. → Push the clamping brackets (10) down until they engage in the bracket guides (12) provided and can not be moved down any further.
7. → As long as the locking element (11) and the locking brackets (10) are not in their original positions, the rotation of the complete mill mechanism is blocked.

5.9.5 Removing the grinding bowl

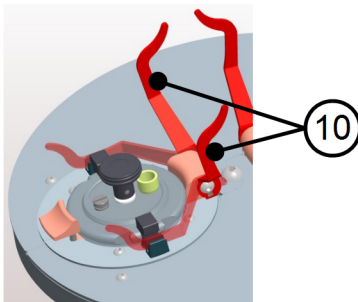

1. → Open the clamping bracket (10).

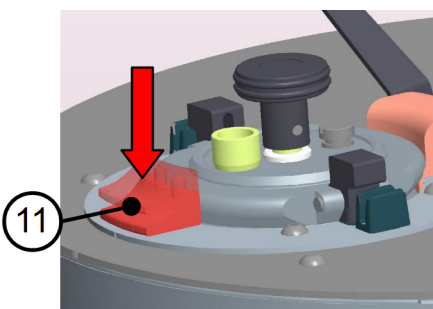

2. → Push the locking element (11) down on the bowl holder.

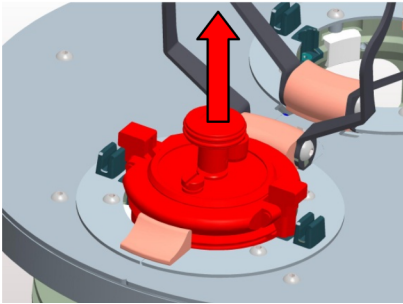

3. → The grinding bowl is unlocked and moves up a few millimetres.

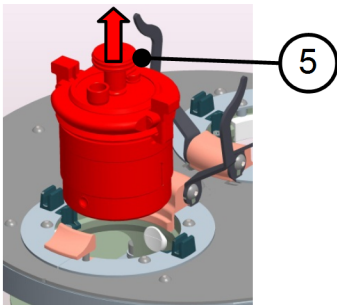

4. → Now, the grinding bowl can be removed (upwards) from its holder. (Hold the grinding bowl preferably at the handle (5) provided for this purpose).

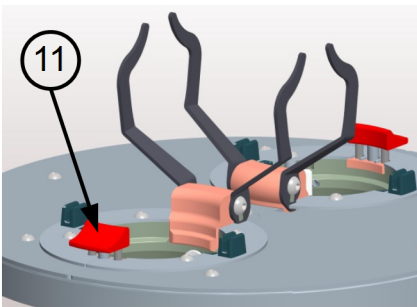

5. → When the grinding bowl is removed, the locking element (11) moves back into its initial position.

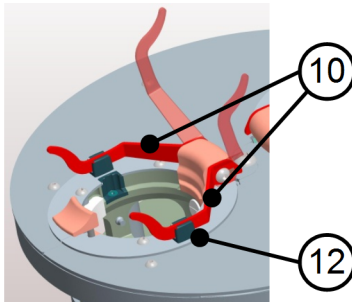

6. → Push the clamping brackets (10) down until they engage in the bracket guides (12) provided and can not be moved down any further.

7. → The loading position can only be changed if the locking elements (11) and clamping brackets (10) that are not in their initial positions and block the milling mechanism reach their initial positions again correctly.

! NOTICE

After a few minutes of grinding and during the cooling phases, check that the condition of the grinding bowls is OK (see → Chapter 5.8 'Wet grinding (grinding in a suspension)' on page 36, → Chapter 5.9.1 'Handling the grinding bowl' on page 38 and → Chapter 5.9.4 'Inserting the grinding bowl in the grinding bowl holder' on page 42).

5.10 Mass balance

Planetary ball mills are generally subject to a specific imbalance during operation. To keep this imbalance as low as possible, all rotating masses in the system must be balanced as completely as possible.

To ensure optimum mass balancing (imbalance correction) of the device, identical grinding bowls and identical grinding bowl fillings must always be used at both grinding stations.

It is quite possible to operate the device with different loads (e.g. different grinding bowl fillings) - however, that will result in a power loss or, depending on the degree of imbalance, in the device shutting down. The request "Please check the imbalance" appears on the display. See → Chapter 5.12.8 'Imbalance check' on page 53.

! NOTICE

It is not possible to specify a permitted mass difference and the resulting imbalance exactly. The permitted mass difference depends on various parameters like rotational speed or stability of the substructure. Basically, the lower the rotational speed, the higher the mass difference can be.

5.11 Grinding duration

Depending on the application, the grinding duration should be adapted to the development of heat of the bowls. When grinding at high speed, a grinding duration of 1 hour (depending on the temperature) should not be exceeded. Then allow the unit to cool down for half an hour to an hour.

If a chemical reaction takes place in the grinding bowl, the result may be the development of a very high pressure in the grinding bowl, without the temperature exceeding 100°C. The pressure must also be released when the grinding bowl has cooled down.

The P-7 premium is not suitable for grinding with steel or tungsten carbide grinding bowls in water suspensions. The application of extremely high energy results in abrasion wear in the nano range. That can result in chemical reactions that cannot be controlled.



To what extent the heating up of the material to be ground needs to be observed naturally depends on the corresponding sample in each individual case. Note → a longer duration may also require a long pause time for cooling down.



If bowls are removed during a grinding pause, check that the bowl is seated correctly before the device is switched back on.

5.12 Conducting a grinding operation

! DANGER

- **Explosion hazard!**
- **Ignition hazard!**
- **Burn hazard!**
- **Wear safety goggles.**
- **Wear safety gloves.**



The following needs to be observed when grinding material for which there is no experience with premium line:

Initially, a grinding duration of 5 minutes should be set and the temperature measured on the actuating screw using a surface thermometer. If it is below 80 °C, grinding can be continued until a temperature of 90 °C is reached. At this temperature, it is advisable to apply a cooling pause of about 15-30 minutes. At the end of the cooling pause, open the knurled screw to check if pressure has built up in the bowl. If there is no high pressure, the grinding and pause times can be programmed in such a way that the temperature does not exceed 90 °C.



During the pause, the mill continues to run at low speed for better cooling. (From firmware V1.08 and higher)

If prolonged blow-off noises and the discharge of source material suspension indicate a high internal pressure after cooling, take special care when you continue to grind. The pressure must always be released after the cooling pauses (at least for 30 minutes in order that the suspension can settle) to prevent it from getting too high. Sooner or later, the increase in pressure will stop.

5.12.1 Program sequence after switching on

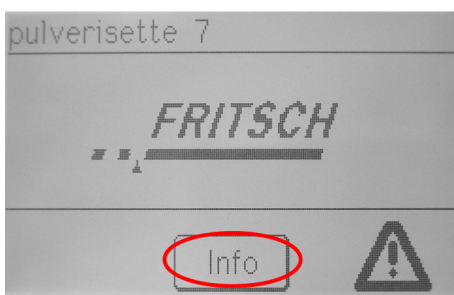

1. → Turn the device on at the main switch.
2. → The display lights up.

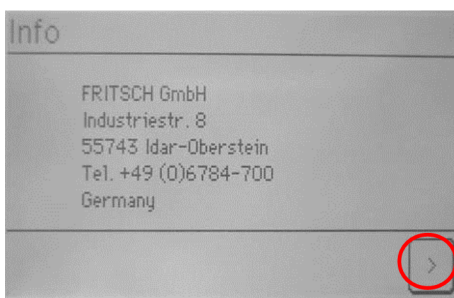

3. → During the start and initialisation phase, you **can** press the INFO button to have information displayed with the contact address. Press the Next button to close this information again.

Using the device

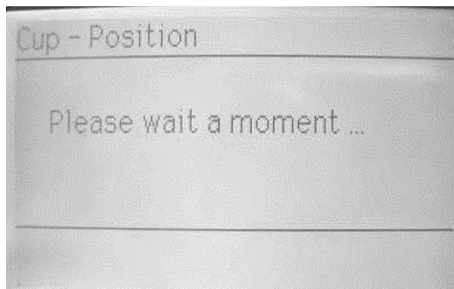

4. Grinding station 1 is moved into the loading position. The grinding chamber cover opens automatically.
5. Insert the grinding bowl (→ Chapter 5.5 'Filling the grinding bowl' on page 34), loaded with the sample (→ Chapter 5.9.1 'Handling the grinding bowl' on page 38) and closed correctly, in the grinding bowl holder (→ Chapter 5.9.4 'Inserting the grinding bowl in the grinding bowl holder' on page 42).

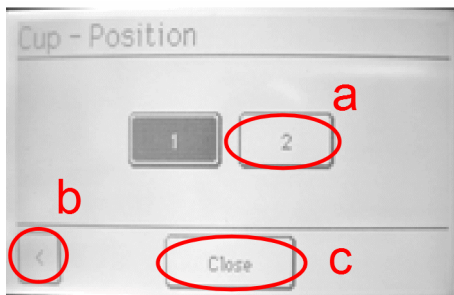

6. Grinding station 1 is moved into the loading position. The grinding chamber cover opens automatically.
7. Insert the grinding bowl (→ Chapter 5.5 'Filling the grinding bowl' on page 34), loaded with the sample (→ Chapter 5.9.1 'Handling the grinding bowl' on page 38) and closed correctly, in the grinding bowl holder (→ Chapter 5.9.4 'Inserting the grinding bowl in the grinding bowl holder' on page 42).

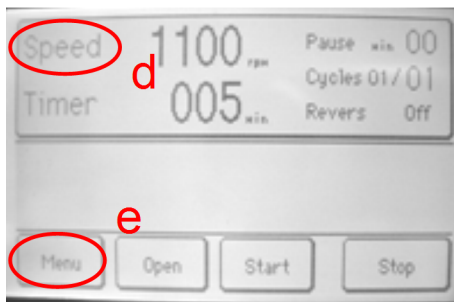

8. You **can** press the Close button (c) to close the grinding chamber.
9. Press the Next button (b) to return to the main menu.
10. To enter the process parameters, either press the indication (d) of the data (touch function) or press the MENU button (e) → press the PARAMETER button (f) to open the parameter input screen.

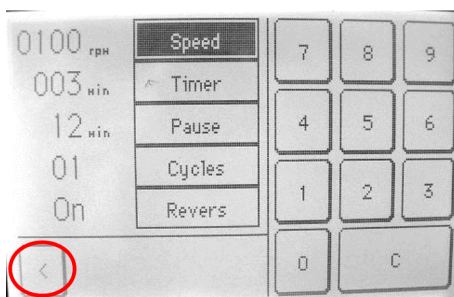
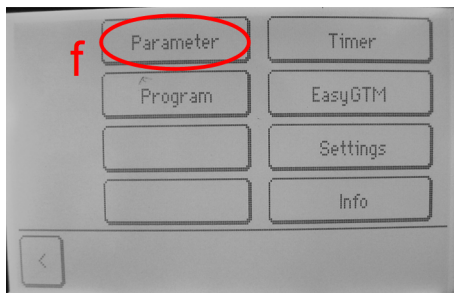

11. The field coloured in black is active. When you start to enter a number, the previous one is deleted, or press the C button to delete the current parameter. Maximum possible entries are:
 Speed = 1100 rpm,
 time = 999 min, pause = 99 min,
 cycles = 99.
12. After entering the parameters, press the < button to return to the main menu.

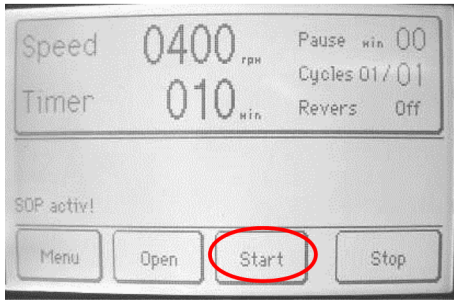

13. → Press the Start button → the grinding chamber is closed and the safety check starts.

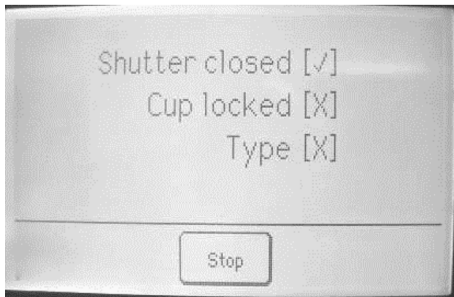

14. → Various sensors check the bowls and the closing mechanism of the device. That will take a few moments. The Stop button stops the process.

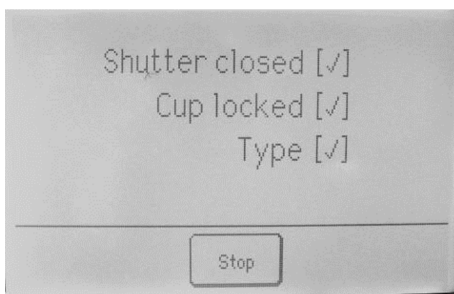

15. → If the check is successful, this is confirmed and grinding is then started without delay.

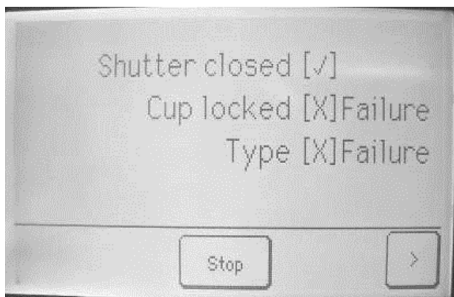

16. → If the sensors detect insufficient safety, the starting procedure is interrupted and the cause is displayed. Press the > button to open the grinding chamber and move grinding station 1 into the loading position. When the error is corrected, grinding can be continued.

5.12.2 Starting grinding at high speed

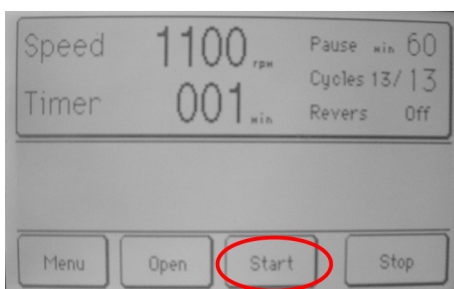

If the speed exceeds 600 rpm, the correct ball size must be selected.



CAUTION

If the wrong balls are selected, they will be destroyed by the high grinding energy.

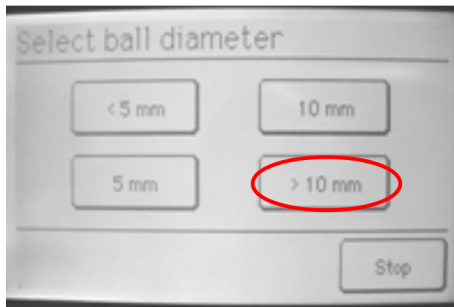

Depending on the choice of the ball size, the maximum speed is reduced.

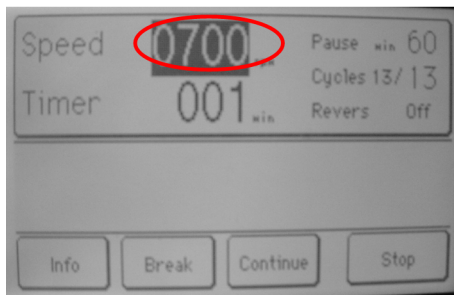

A reduced speed is indicated briefly by a flashing target speed indicator.

The Stop button stops the grinding process.

Press the Info button to display some system information and the type of grinding elements.

Reference values for the speed limit		
Ball diameter (mm)	Speeds (rpm) for agate	Speeds (rpm) for all other materials
<5	1100	1100
5	900	1000
10	750	850
>10	600	700

5.12.3 Overload

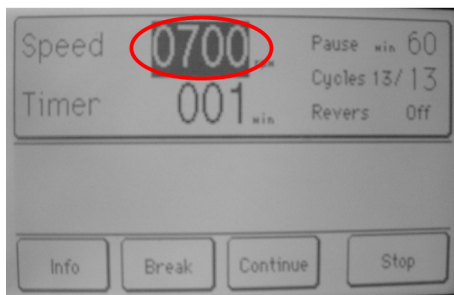

If the planetary micro mill is overloaded, the speed is reduced. The reduced speed flashes on the display.

5.12.4 "Program" menu item

Grinding cycles can be programmed, saved and selected here.

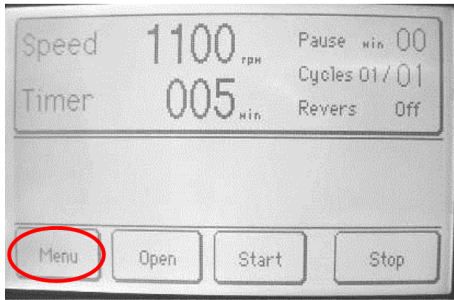

1. → Press the "Menu" button in the main menu.

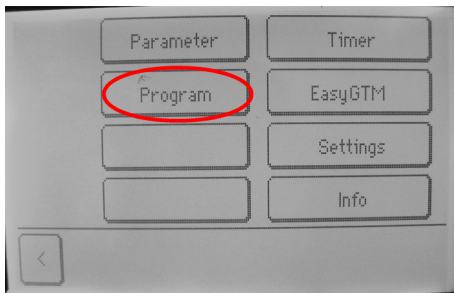

2. → Then press the "Program" button → A new window appears.

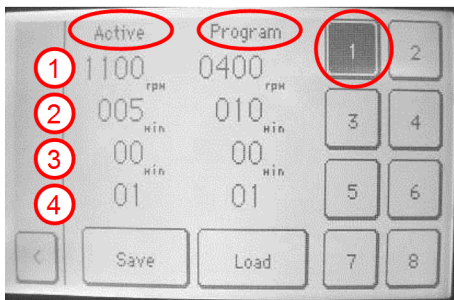

3. → The "Current" column shows the current parameters of previous entries.

4. → The "Program" column shows the data previously stored under button 1.

5.12.5 Saving the current data

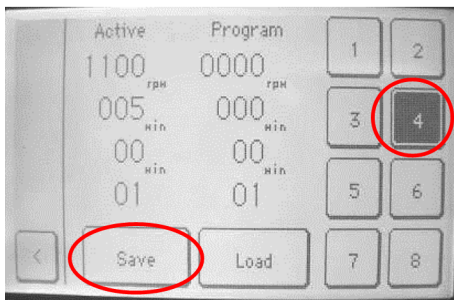

1. → First select the program section that is free or to be overwritten.

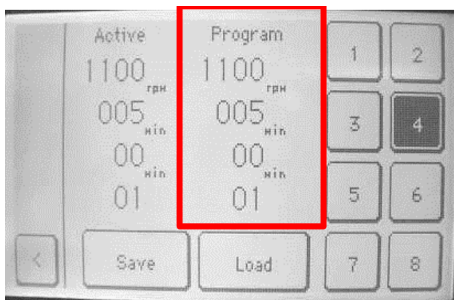

2. → Then, press the Save button to save the current parameters to the selected program section.

3. → After saving them successfully, the new parameters are now displayed in the "Program" column.

5.12.6 Loading the program

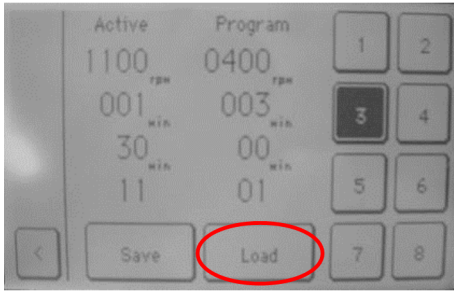

1. → Select one of the programs 1..8, the various parameter records are displayed in the Program column.

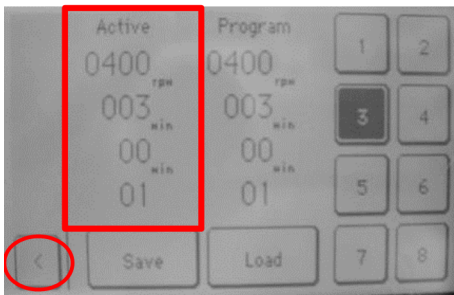

2. → Press the "Load" button to transfer the program data record.



3. → Press the "<" button to return to the main menu. The program is disabled by manual input e.g. of the speed (see → Chapter 5.12.1 'Program sequence after switching on' on page 46).

5.12.7 Setting the time control

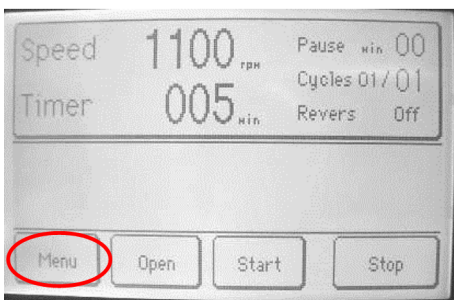

1. → Select Menu.

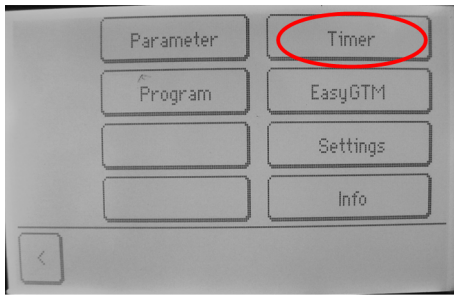

2. → Select Clock.

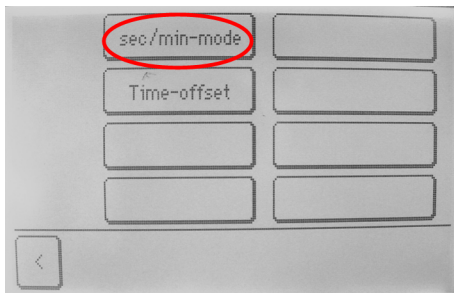

3. → Select the time base for the internal clock.

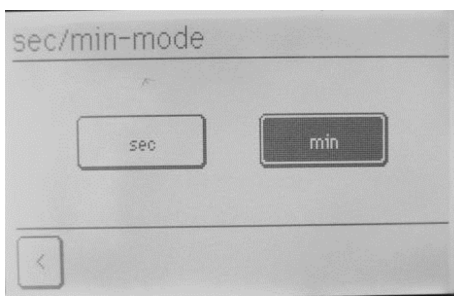

4. → Press the "<" button to confirm your entry

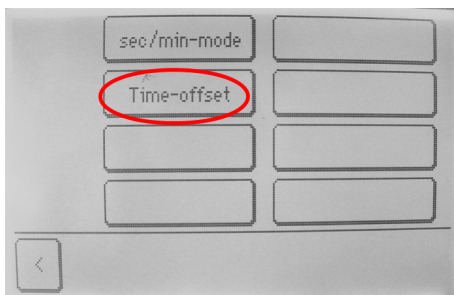

5. → Enter the time offset. By entering a time offset, grinding is only started after this delay in time. This function is displayed as active in the main menu.

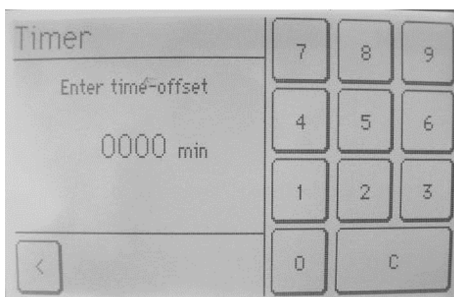

6. → Press the "<" button to confirm your entries
➔ The time offset is reset to 0000 after grinding.

5.12.8 Imbalance check

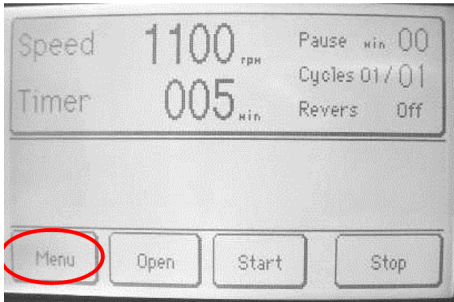

The distribution of different weights in both bowls will obviously result in different vibrations, also depending on the speed.

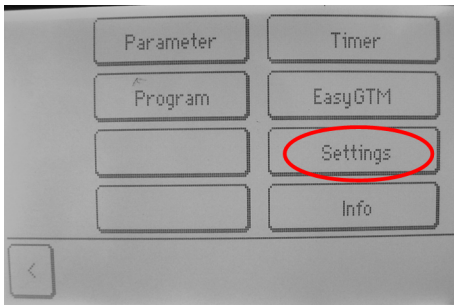

To tolerate this imbalance within specific limits, you can set the shut-down threshold.

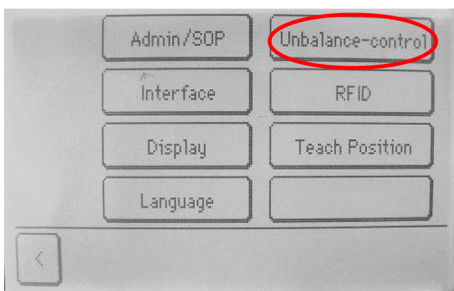

Touch the adjustment bar or move it back and forth by applying slight pressure.

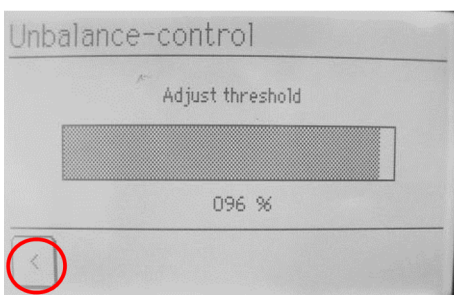

Press the "<" button to confirm your entries

 *Small setting values make the measuring system more sensitive, and high values make it less sensitive.*



5.12.9 Switching off

! NOTICE

If the permissible maximum temperature in the bowl is exceeded during grinding, then the device must not be switched off with the lid closed. That could lead to heat accumulation in the machine, which could cause damage to the device.

Provide sufficient cooling by letting the mill continue to run at a speed of 150 rpm for approx. 20 - 30 min. or by shutting off the mill with the lid open.

- 1.** → Press "STOP" on the display.
- 2.** → When the drive comes to a stop, grinding station 1 is moved into the loading position and the grinding chamber cover opens automatically.
- 3.** → If the device is put out of service for a lengthy period, close the grinding chamber cover and turn the device off at the main switch.

5.12.10 Cooling the grinding bowl

The grinding bowls can be cooled

- 1.** → with the grinding chamber cover open and the fan running (the fan continues to run for 1 minute);
- 2.** → or by the programmed pause times with closed (locked) grinding chamber cover and the fan running.

6 Accessories

6.1 Standard gassing lid for grinding with inert gas

! NOTICE

Our workers perform a water bath test on all gassing lids. The part to be tested is sealed, a pressure of 5.5 bar is applied and it is immersed in a water bath. If there is a leak, bubbles will develop. The air bubbles that develop within a specific interval are evaluated by the worker/tester.

Only gassing lids with a leak rate of $<10^{-4}$ [mbar l/s] are approved.

6.1.1 Scope of delivery

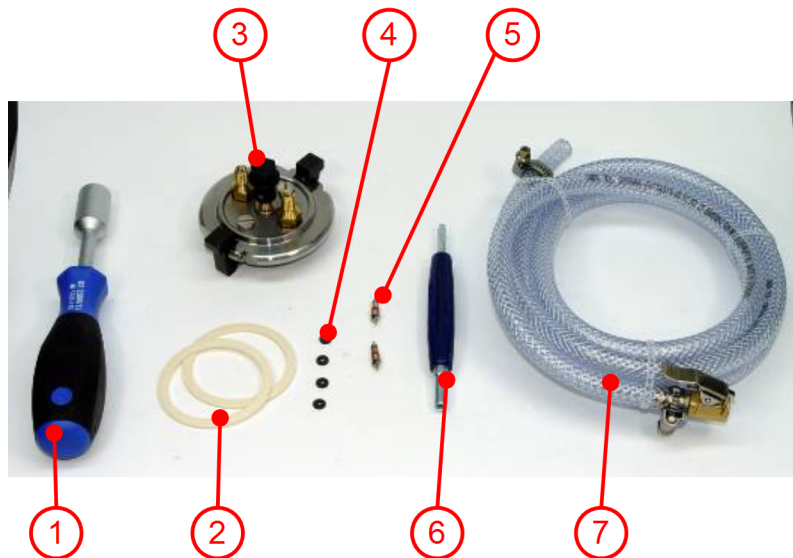

- | | |
|--|--|
| (1) Hexagon socket wrench, 13mm | (4) 4 x flat seal 6.3x1.8x1mm, viton, for valves (replacement) |
| (2) 2 x flat seal 57.5x48x2mm, silicone, for grinding bowl (1 x replacement) | (5) 2 x valve inserts (replacement) |
| (3) Compl. gassing lid | (6) Valve key for turning the valve inserts out of the valve |
| | (7) Hose with adapter on valve |

6.1.2 Fitting the gassing lid on the grinding bowl



(9) Gassing lid handle

1. → Place the silicone flat seal (2) on the edge of the bowl insert.



2. → The central handle (9) must be removed as illustrated.

3. → Hold the lid at the hook. Push the hook up and place the lid on the bowl.



4. → Turn the lid with the hooks pressed outwards on the bowl, until the lugs of the hooks engage in the recesses on the edge of the bowl fitting (→ Chapter 5.9.3 'Closing the grinding bowl' on page 40).



5. → After releasing the hooks, they must be immersed completely in the recesses on the outer diameter of the bowl fitting and be exactly vertical.



6. → Push the central handle (9) down by hand until the resistance increases.



7. → Use the hexagon socket wrench (1) to tighten it with maximum manual force. The maximum manual force is equivalent to a torque of approx. 3.5-4Nm.



8. → This is what the closed grinding bowl looks like.

6.1.3 Hose adapter for grinding bowl gassing



(11) Locking lever

1. → Push the locking lever (11) of the connection on the hose inwards.



2. → Push the hose connection onto the valve (8) and down onto the inner seal. At the same time, the valve is opened by an internal pin in the hose connection. When the locking lever is released, it engages on the valve thread.



3. → For flushing, the second valve can be opened with a pen, e.g. the tip of a ballpoint pen.

! NOTICE

The gas must be supplied very slowly to avoid any turbulence in the grinding bowl or of the material to be ground when it is inserted.

4. → After gassing the sample, remove the hose (7) again. The grinding bowls are inserted and handled as shown in [Chapter 5.1 'Using the device'](#) on page 25.

6.1.4 Removing the gassing lid in individual steps

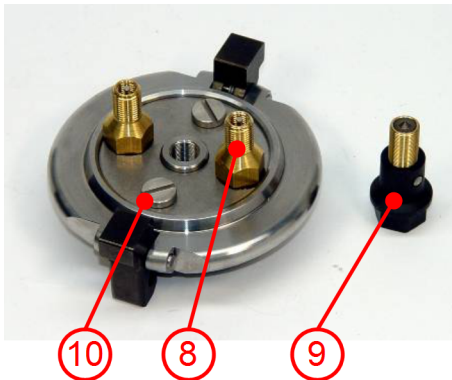

- (8) Valve
- (9) Gassing lid handle
- (10) Actuating screw

1. → Turn the central handle (9) and remove it by hand.

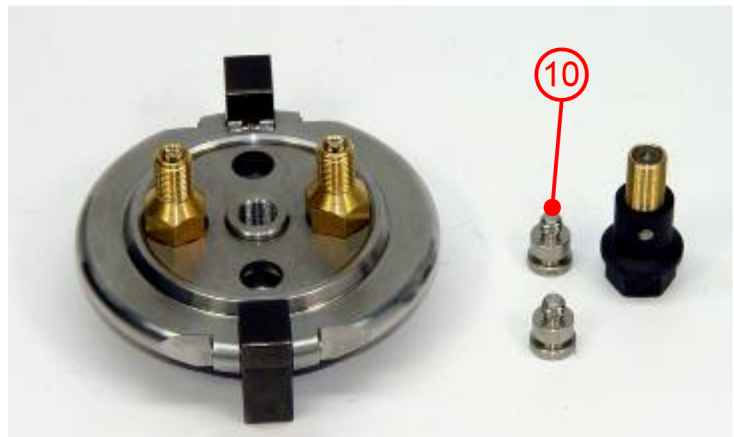

- (10) Actuating screw

2. → Unscrew the two actuating screws (10) with a broad slotted screwdriver (tightening torque approx. 4-5Nm = maximum manual force).

3. → Unscrew the two valves (8) using the socket wrench (1) (tightening torque approx. 3.5-4Nm = maximum manual force).





(4) Flat seal

4. → Remove the flat seals (4) under the valves. The flat seals are deformed by the contact pressure.

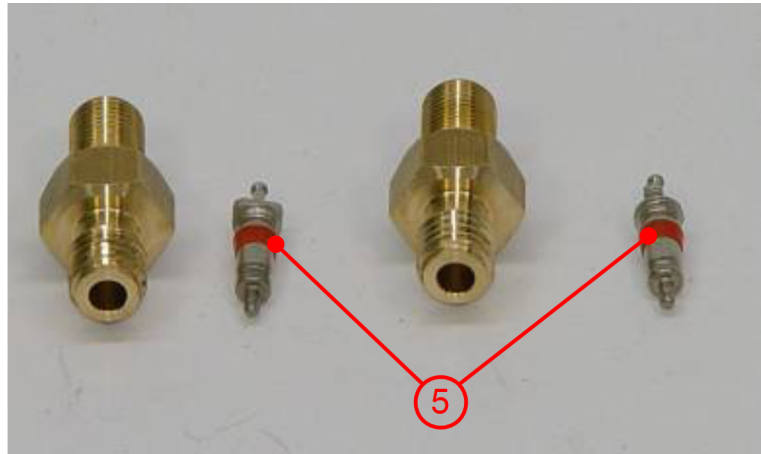

(5) Valve insert

5. → Turn the two valve inserts out of the valves using the valve key (6). (Tightening torque approx. 1.5-2Nm = average manual force). The valve is held in place using the socket wrench (1), and the valve insert (5) is removed using the valve key (6).

! NOTICE

Do not forget to insert the two valve flat seals (4).

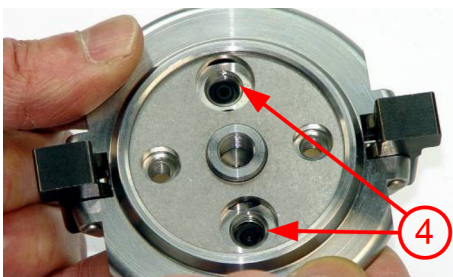

(4) Flat seal

6. → The gassing lid is removed in the reverse order.

6.2 Gassing lid with stainless steel, swagelok hose couplings

! NOTICE

Our workers perform a water bath test on all gassing lids. The part to be tested is sealed, a pressure of 5.5 bar is applied and it is immersed in a water bath. If there is a leak, bubbles will develop. The air bubbles that develop within a specific interval are evaluated by the worker/tester.

Only gassing lids with a leak rate of $<10^{-4}$ [mbar l/s] are approved.

6.2.1 Scope of delivery / lid design

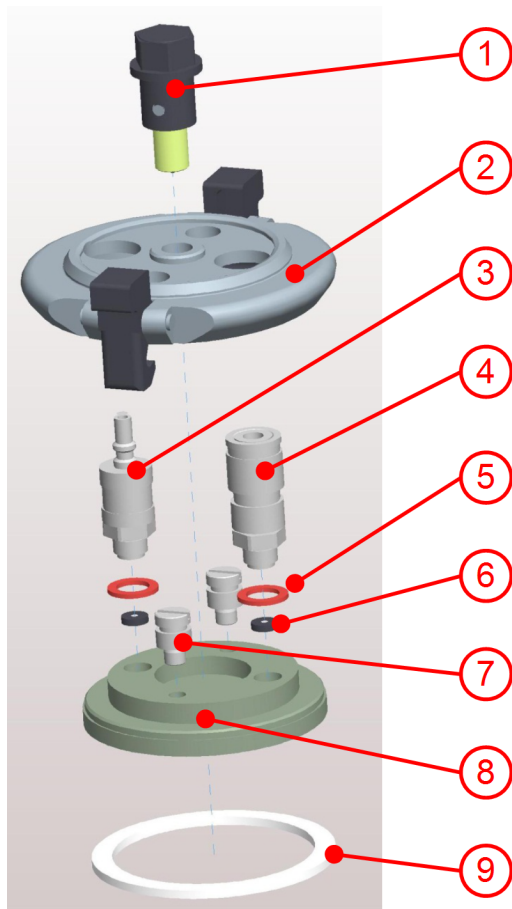

- 1 Compl. gassing lid handle
- 2 Compl. gassing lid fitting
- 3 Gassing valve connecting plug
- 4 Gassing valve quick-release coupling
- 5 Sealing ring 8x12x1mm, vulcanised fibre
- 6 Flat seal

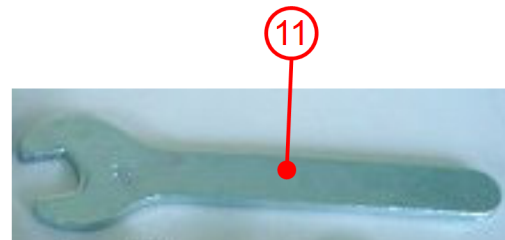
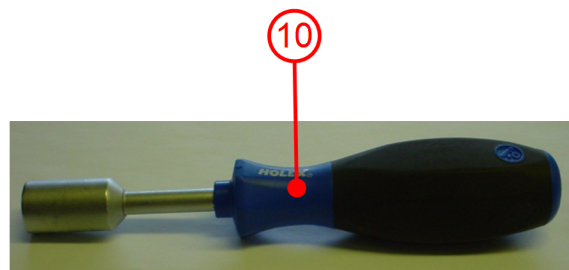

- 7 Actuating screw
- 8 Gassing lid insert
- 9 Flat seal, 57.5x48x2, silicone
- 10 Hexagon socket wrench size 13
- 11 Single head wrench, size 11

6.2.2 Fitting the gassing lid on the grinding bowl



1. → Place the silicone flat seal (9) on the edge of the bowl insert.



2. → Place the gassing lid insert (8) with the seal gassing valves (3 and 4) and actuating screws (7) on the flat seal (9) in the bowl.

3. → Hold the lid (2) at the hooks. Push the hooks outwards and place the lid (2) on the bowl above the gassing lid insert (8).



4. → The central handle (1) must be removed as illustrated.



5. → Turn the lid (2) with the hooks pressed outwards on the bowl, until the lugs of the hooks engage in the recesses on the edge of the bowl fitting (→ Chapter 5.9.3 'Closing the grinding bowl' on page 40). After releasing the hooks, they must be immersed completely in the recesses on the outer diameter of the bowl fitting and be exactly vertical.



6. → Push the central handle (1) down by hand until the resistance increases. Use the hexagon socket wrench (10) to tighten it with maximum manual force. The maximum manual force is equivalent to a torque of approx. 3.5-4Nm.



7. → This is what the closed grinding bowl looks like.

6.2.3 Hose adapter for grinding bowl gassing



- 1 Quick-release coupling structure 'SS-QM2-B-2PM' (Order no. 50.9797.00)
- 2 Quick-release coupling connector 'SS-QM2-D-2PM' (Order no. 50.9796.00)

The valves of our grinding bowls, from the Swagelok QM series with the connection size 1/8 inch, are subject to technical adaptation by us, but can be adapted for the customer's connection with the corresponding series components from the QM series.



For the exact configuration and customer connection to our grinding bowls, please visit the original manufacturer's page to ensure that the hoses and counterparts used meet the specific requirements of your application. Please note that we cannot guarantee the accuracy and completeness of the information provided by Swagelok. See → www.swagelok.com.

6.2.4 Removing the gassing lid in individual steps

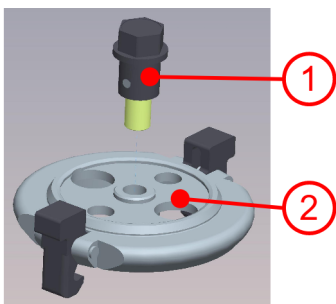

- (1) Compl. gassing lid handle
- (2) Compl. gassing lid fitting

1. → Turn the central handle (1) and remove it by hand.

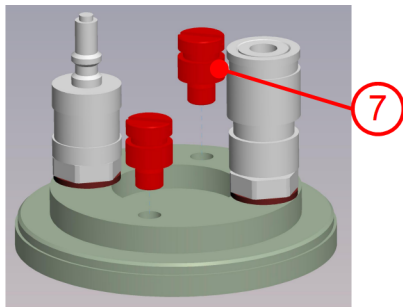

7 Actuating screw

2. → Unscrew the two actuating screws (7) with a broad slotted screwdriver (tightening torque approx. 4-5Nm = maximum manual force)

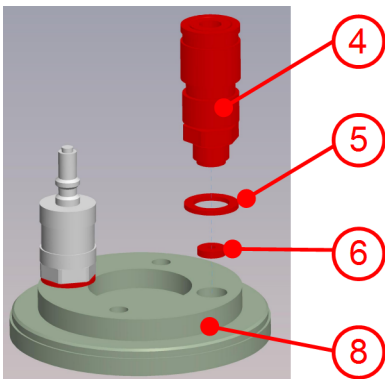

4 Gassing valve quick-release coupling
5 Sealing ring 8x12x1mm, vulcanised fibre
6 Flat seal
8 Gassing lid insert

3. → Unscrew the two valves (3 and 4) using the size 11 single-head wrench (11) (tightening torque approx. 3.5-4Nm = maximum manual force)

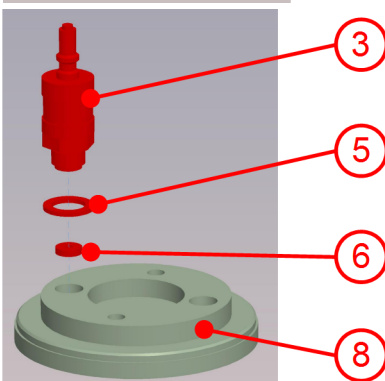

3 Gassing valve connecting plug
5 Sealing ring 8x12x1mm, vulcanised fibre
6 Flat seal
8 Gassing lid insert

4. → Remove the seals (5 and 6) from under the valves. The seals are deformed by the contact pressure.

! NOTICE

Do not forget to insert the two valve flat seals (5 and 6).

5. → The gassing lid is fitted in the reverse order.

6.3 Gas Pressure and Temperature Measuring System

The EASY-GTM gas pressure and temperature measuring system is used to control the grinding process and for mechanical alloying.

! NOTICE

If grinding balls with a diameter of 1 mm or smaller are used, there is a risk of the through holes in the lid getting clogged, which could falsify the pressure and temperature measurement. If these ball sizes are used nevertheless, the grinding process must not be carried out unobserved. The intermediate lid should be checked at regular intervals during the grinding process. When the MillControl software is used, the pressure and temperature are displayed. If the pressure remains constant, the cause of this may be a clogged intermediate lid.

6.3.1 Case contents and system design



- | | | | |
|---|---|----|--|
| 1 | 2,6 Nm torque spanner + hexagonal bit | 6 | Hexagon screwdriver, 3 mm |
| 2 | EASY-GTM system | 8 | Measuring/transmission unit |
| 3 | Flat sealing ring, 57,5 x 48 x 1 made of Viton (50.9888.15) | 9 | Lid |
| 4 | O-ring, 21x2,5 | 10 | Compl. bowl |
| 5 | Hexagon offset screwdriver, 2,5 mm | 11 | Locking ring with 6 socket head screws |

6.3.2 Inserting / changing the battery

When inserting it for the first time and during subsequent replacement of the battery, proceed as follows:



1. → If not already done, switch off the radio system using the button (A). The LED (B) goes out.



2. → Then release the six socket head screws (C) for closing the system using a hexagon screwdriver (6). The locking ring (11) with 6 socket head screws can be removed now. (see → Chapter 6.3.11 'Cleaning the EASY-GTM system' on page 76)



3. → **Carefully** lift the measuring/transmission unit (8) off the bowl (10).



4. → If the lid (9) is on the unit, release it by hand and place it to the side. The lid normally remains on the bowl (10).



5. → Undo the two screws (D) of the battery compartment using a hexagon offset screwdriver, size 2.5mm (5).

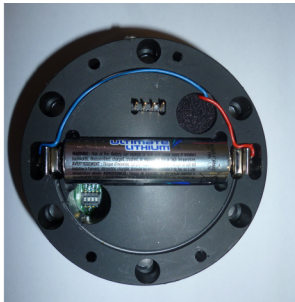

6. → Lift off the battery compartment lid and place it to the side. The battery compartment can be seen.

! NOTICE

Please note that the the battery (2) fits exactly in place and may need to be pushed in using a certain amount of force.

The service life of the battery (2) depends on the frequency of the radio protocols (see configuration) and essentially on the temperature inside the grinding bowl.

Also pay attention to the battery's charge level. If the battery's capacity falls below 10%, it should be replaced immediately.

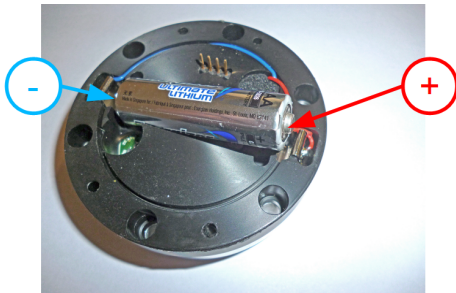

- 7.** → Remove the old battery and insert the new battery (2). Battery type: 1.5V / AA Lithium



When inserting the battery pay attention to the polarity!

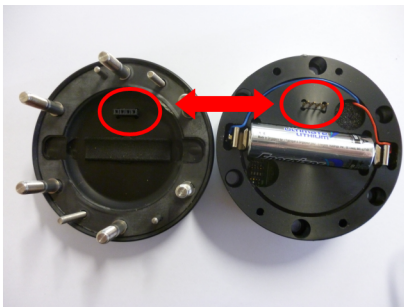

- 8.** → Close the battery compartment! Make sure the plug contacts are in the correct position!

6.3.3 Configuration of transmitter ID and data transmission frequency

The measuring/transmission unit (12) is equipped with four configuration switches for setting the transmitter ID and data transmission frequency.

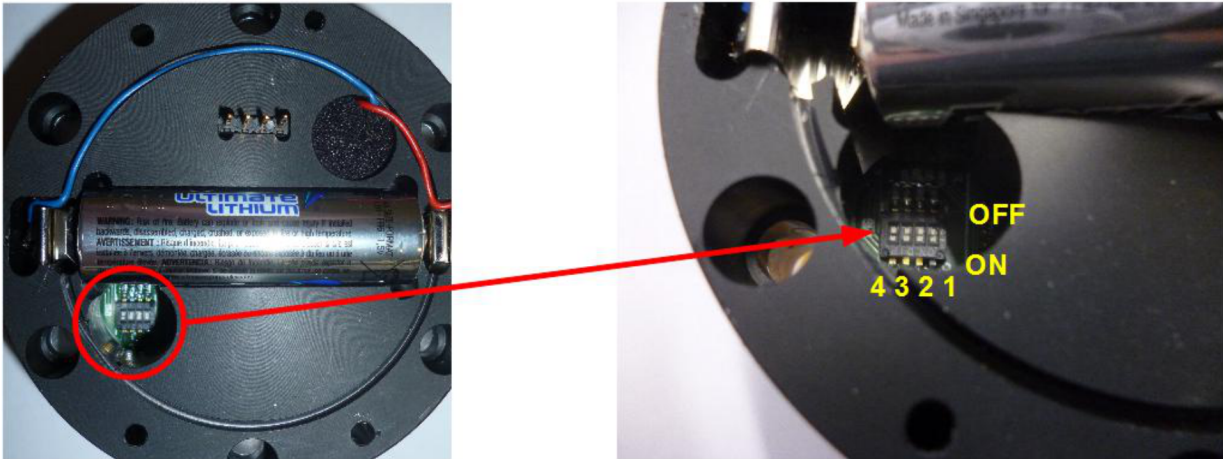

The switches illustrated are all **OFF** (actuator cams set to OFF).

6.3.3.1 Adjustment options of the transmitter detection

In the delivery condition all switches are set to OFF. It is recognised that, in this case, bowl 1 and the transmission frequency of 1 second are the set values. The bowl with ID 1 must then also be inserted in the indicated position 1 of the mill. Similarly the EASY-GTM system with ID 2 must be positioned in position 2 of the mill.

ID	Switch 1	Switch 2
Transmitter no. 1	OFF	OFF
Transmitter no. 2	ON	OFF



If other switch settings are set, the EASY-GTM systems will not be recognised. Ensure that the settings shown in the table are used for your systems and that they are used in the correct position in the mill.

6.3.3.2 Transmission frequency setting options

Transmission every	Switch 3	Switch 4
1 second	OFF	OFF
½ second	ON	OFF
¼ second	OFF	ON

Transmission every	Switch 3	Switch 4
automatic	ON	ON

1-second transmission is the default value.

For automatic transmission, the 1 / 1/2 / 1/4 second transmission frequency is switched over in the event of fast changes in pressure or temperature.

The data transmission frequency naturally also has an impact on the battery's service life.

1-second operation results in the longest time span.

The transmission frequency can also be checked visually: as soon as the transmission unit is switched on, the switch flashes each time data is transmitted.

6.3.4 Installation of the transmission unit on the EASY-GTM bowl

! NOTICE

The threaded holes inside the bowl, the passage holes and the Allen screws in the locking ring have to be cleaned thoroughly after each grinding to allow a safe fastening of the EASY-GTM system.

The EASY-GTM system must be assembled as follows before inserting the EASY-GTM system in the micro mill:



1. → Insert the seal in the bowl!



2. → Insert the intermediate lid!

! NOTICE

Always insert the intermediate lid before grinding with the EASY-GTM system! Fritsch assumes no guarantee for damage caused by grinding without the intermediate lid!



3. → Apply the transmitter with seal!



4. → Tighten the socket-head screws crosswise with a torque spanner (1) until it disengages! To be on the safe side, re-tighten all screws again after initially tightening them. All screws are secured against becoming loose during the grinding process once they have been tightened with the torque spanner as described.



Fritsch GmbH assumes no guarantee for damage caused by grinding with loose screws!

5. → Switch on the transmitter with the On/Off button (A) and insert the bowl as described in → Chapter 5.9.4 'Inserting the grinding bowl in the grinding bowl holder' on page 42!

! NOTICE

Check the fitting of the transmission unit again after inserting the bowl!

! NOTICE

During a grinding, during the pauses, the correct position of the Allen screws of the transmission unit must to be checked. If screws became loose, re-tighten them.

6.3.5 Installation of the receiver board in the P-7 premium

! DANGER



Before starting the installation, disconnect the mains plug and protect the device against being unintentionally switched back on.

Secure installation work with a warning sign.

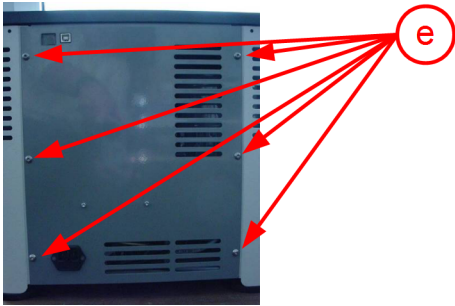

1. → The 6 screws (e) used to attach the rear panel to the housing are undone and the rear panel is opened carefully.

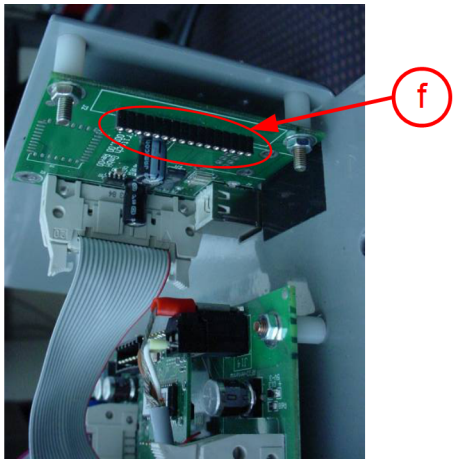

2. → The PKM interfaces board (81.0011.00) is on the rear panel, with the slot (f) for the receiver module 81.0013.00.

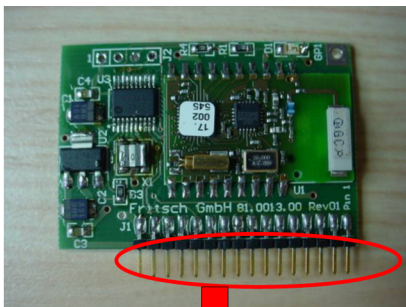

3. → Insert the receiver module in the corresponding slot. (As illustrated)

4. → Close the rear panel of the housing again and screw it tight.

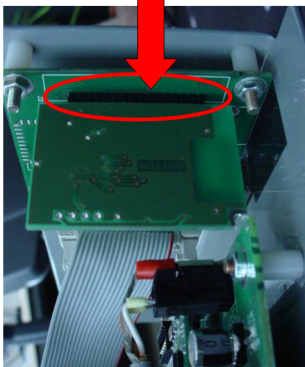

6.3.6 Activating EASY-GTM

If the device is protected by SOP mode (→ Chapter 7.1 'Standard Operation Procedure' on page 85), please contact the P-7 premium administrator. This mode must be deactivated, otherwise only programs already stored can be loaded for operation.



To activate the EASY-GTM system, proceed as follows:

1. → Select Menu.

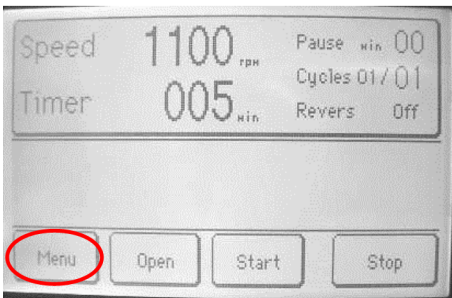

2. → Select "EasyGTM" sub-menu.

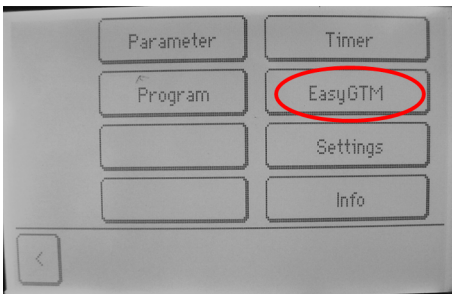

3. → Activate EASY-GTM.



4. → The inverted button indicates the current status.

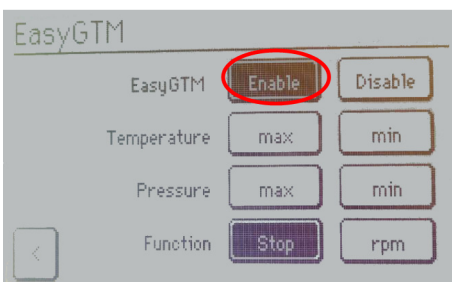

6.3.7 Entering the temperature limit

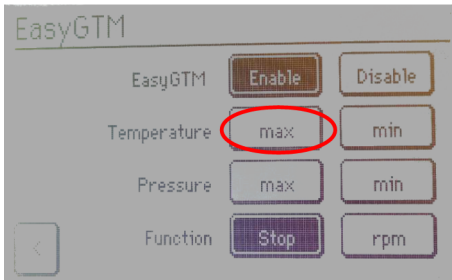

1. Select the maximum temperature input.



If the max. temperature is reached, the device stops the grinding process and goes into cooling mode! Depending on the setting of the operating mode, see → Chapter 6.3.9 'Selecting the operating mode' on page 75, the device stops the grinding process and opens the grinding chamber cover or reduces the speed gradually until a minimum speed is reached in order to achieve an optimal cooling effect.

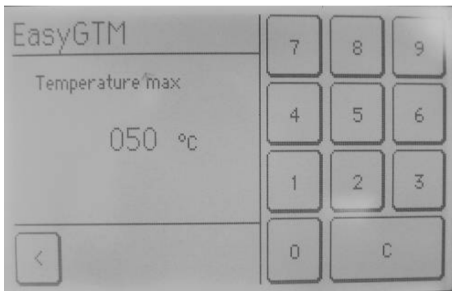

2. Enter the required max. temperature limit.



Do not exceed a maximum temperature of 125°C. Otherwise, the EASY-GTM system and the machine will be damaged.

3. Use the [↵] button to confirm your entry and return to the EASY-GTM sub-menu.

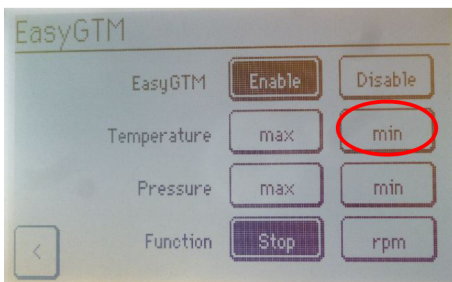

4. Select the minimum temperature input.



When the selected min. temperature (e.g. 60 °C) is reached again during the cooling phase, the mill starts the grinding process again.



5. Enter the required min. temperature limit.

6. Press the [↵] button to confirm your entry and return to the EASY-GTM sub-menu.



6.3.8 Entering the pressure limit

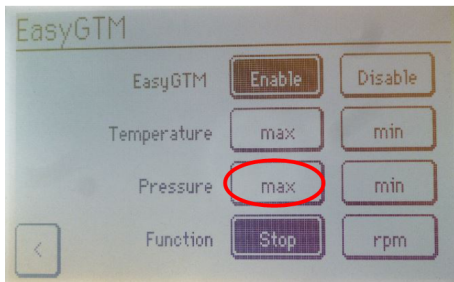

1. → Select the maximum pressure input.



If the max. pressure is reached, the device stops the grinding process and goes into cooling mode! Depending on the setting of the operating mode, see → Chapter 6.3.9 'Selecting the operating mode' on page 75, the device stops the grinding process and opens the grinding chamber cover or reduces the speed gradually until a minimum speed is reached in order to achieve an optimal reduction of pressure.



2. → Enter the required max. pressure limit.



DANGER

Do not exceed a maximum pressure of 20 bar. Otherwise, the EASY-GTM system and the machine will be damaged.

3. → Use the [**<**] button to confirm your entry and return to the EASY-GTM sub-menu.

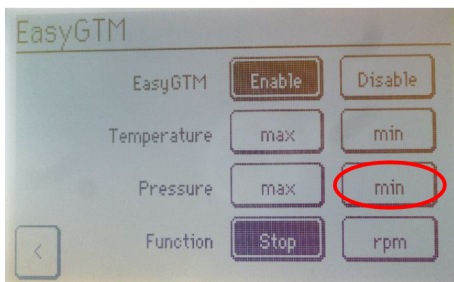

4. → Select the minimum pressure input.



5. → Enter the required min. pressure limit.



When the selected min. pressure (e.g. 2 bar) is reached again during the cooling phase, the mill starts the grinding process again.

6. → Press the [**<**] button to confirm your entry and return to the EASY-GTM sub-menu.

6.3.9 Selecting the operating mode

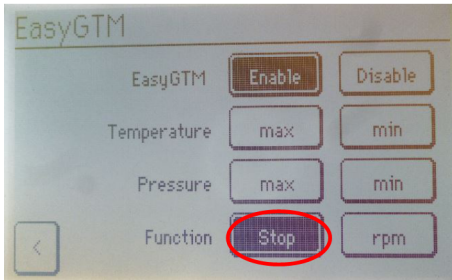

You can use the Function menu item to select how the P-7 premium is to respond to the temperature or pressure limit being reached.

rpm:

With this setting, the P-7 premium gradually reduces the speed down to a minimum speed. If these two limit settings are fallen short of significantly, the device accelerates back to the operating speed.

Stop:

As soon as one of the two limits is reached, the ball mill shuts down immediately. If the limits are fallen short of, restart is disabled.

Press the "<" button to confirm all entries and return to the main menu.

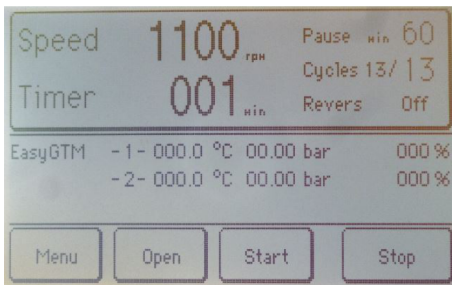

6.3.10 Deactivating EASY-GTM

To deactivate the EASY-GTM system, proceed as follows:

1. → Select Menu.

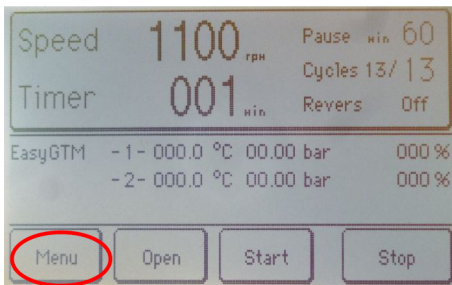

2. → Select "EasyGTM" sub-menu.

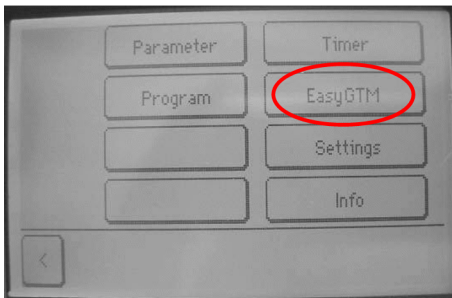

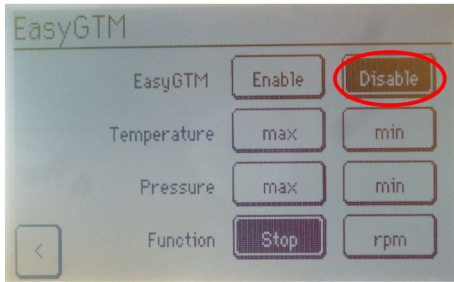

3. → Deactivate EASY-GTM.
4. → Press the[<] button to confirm your entry and return to the main menu.

6.3.11 Cleaning the EASY-GTM system

! NOTICE

The threaded holes inside the bowl, the passage holes and the Allen screws in the locking ring have to be cleaned thoroughly after each grinding to allow a safe fastening of the EASY-GTM system.

! NOTICE

The measuring/transmission unit should not be immersed in water. It can be rubbed down with a damp cloth if necessary.



Remove the locking ring (11) including the screws of the measuring/transmission unit and clean it completely.

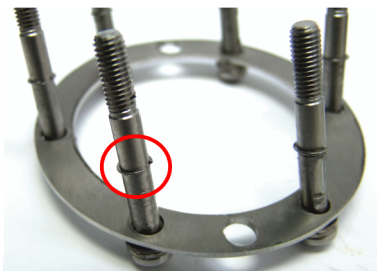

The screws are provided with a snap ring, which prevents them to fall out of the locking ring (11). Pay attention to the position of the snap rings! (see picture!)



Insert the locking ring!



The lid normally remains on the bowl (10).

If the lid (9) is on the measuring/transmission unit (8), release it by hand before cleaning. The lid (9) and the bowl (10) can be cleaned under running water as described in → Chapter 8.1 'Grinding elements' on page 92



6.3.11.1 Cleaning the sensor and replacing the seal

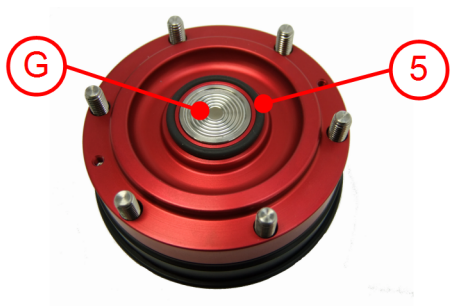

The sensor (G) must not be subjected to any mechanical stress. It is permitted to cleaning it with a wet cloth. The O-ring (5) can be replaced if necessary.

6.3.12 Battery arrangement

According to the "DIRECTIVE 2006/66/EC OF THE EUROPEAN PARLIAMENT AND COUNCIL as of 6th September 2006 on batteries and rechargeable batteries and on old batteries and old rechargeable batteries and for the annulment of Directive 91/157/EEC" and article 1, §18 and article 2 of the German Act on the re-definition of the waste legislation on the product responsibility for batteries and rechargeable batteries (BattG) as of 25.06.2009, we are legally obliged as the manufacturer to inform you as the consumer about the following:

The EASY-GTM product we sell contains a lithium battery, type AA, 1.5V, that can be discharged once.

When the battery is flat, it may not be disposed of along with household waste. Old batteries may contain harmful substances that can pollute the environment or damage your health. Please deliver the batteries to the regional recycling point/collection point. Please only place discharged/flat batteries in the containers intended for this purpose. Cover the terminals of lithium batteries with adhesive tape first.



All batteries and rechargeable batteries are reused. Valuable substances, such as zinc, iron and nickel can thus be recycled. Battery recycling is one of the easiest environmental protection measures. The crossed-out dustbin symbol means that (rechargeable) batteries may not be disposed of along with household waste.

You can, of course, also return discharged batteries - with sufficient postage - by post to:

Fritsch GmbH
Milling and Sizing
Industriestrasse 8
D-55743 Idar-Oberstein, Germany

For information on removing the battery, see ➔ *Chapter 6.3.2 'Inserting / changing the battery' on page 65.*

6.4 Special emptying device for grinding bowls

Special emptying device for grinding bowls of the P-7 premium enables the fast and simple separation of the grinding balls and suspension after grinding.

It is suitable for all grinding bowl sizes (80 ml, 45 ml and 20 ml).

2 strainers with a mesh width of 0.08 mm and 0.8 mm are available.

6.4.1 Design

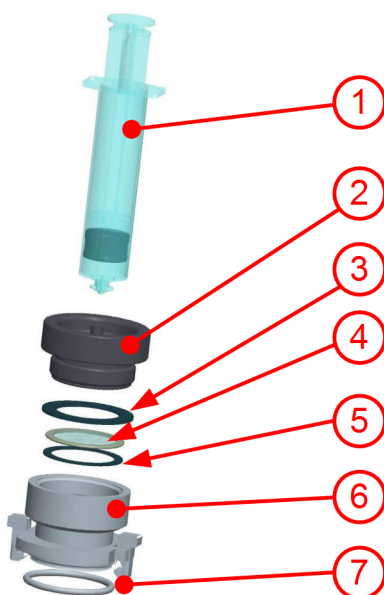

- 1 Syringe pump tip
- 2 Funnel lid for special emptying device
- 3 Flat seal, 58x41x2.0
- 4 Stainless steel strainer
- 5 Flat seal, 50.5x41x1.5
- 6 Adapter for special emptying device
- 7 O-ring, 49x4

6.4.2 Handling



1. → Remove the bowl with the balls and the suspension from the device after grinding and remove the lid. → Chapter 5.9.2 'Opening the grinding bowl after a grinding operation' on page 38



2. → Fit the adapter (6) with stainless steel strainer (4) and seals (2, 5, 7) firmly on the grinding bowl and tension it like a lid. → Chapter 5.9.3 'Closing the grinding bowl' on page 40



3. → Screw on the funnel lid (2) for holding the syringe on the adapter (6)!

4. → Fill the syringe (1) with 10ml air.



- 5. → Screw the syringe (1) onto the funnel lid (2) of the special emptying device.
- 6. → Inject the air in the syringe (1) into the bowl.

- 7. → Shake the bowl with the suspension.



- 8. → Pump 2-5 times with the syringe and then mount the syringe (1).
- 9. → Now, the suspension is in the syringe.

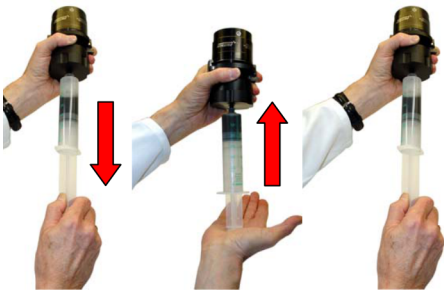

- 10. → Unscrew the syringe (1) from the funnel lid (2).
- 11. → Solvent can again be injected into the bowl using the emptied syringe to extract the last remains of the sample, Repeat the procedure 5 to 10 times.





- 12.** → Open the system by turning the funnel lid (2) down and separate the adapter (6) by pushing the locking hooks off the grinding bowl.
- 13.** → The suspension is in the syringe and the balls are lying on the stainless steel strainer (4)!

6.4.3 Cleaning the special emptying device

It is cleaned under running water. To do this, remove all parts to be able to clean the seals properly as well. Then dry the parts with a cloth or a blow-dryer. During installation, pay attention to the correct sequence and position of the seals. → Chapter 6.4.1 'Design' on page 78

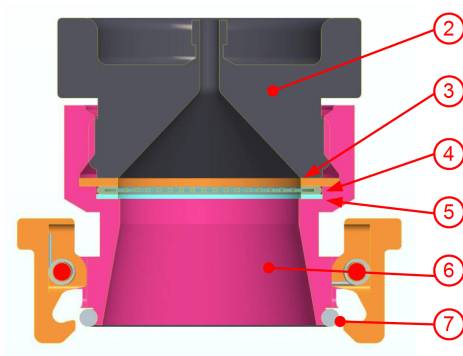

- 2 Funnel lid for special emptying device
- 3 Flat seal, 58x41x2.0
- 4 Stainless steel strainer
- 5 Flat seal, 50.5x41x1.5
- 6 Adapter for special emptying device
- 7 O-ring, 49x4

6.5 Compl. counterweight

The device is generally subject to a specific imbalance during operation. To keep this imbalance as low as possible, all rotating masses in the system must be balanced as completely as possible.

To ensure optimum mass balancing (imbalance correction) of the device, identical weights must always be used at both grinding stations (→ Chapter 5.10 'Mass balance' on page 44).

The counterweight is used for weight balancing if only one grinding bowl is inserted with a sample in the p-7 premium line.



6.5.1 Design

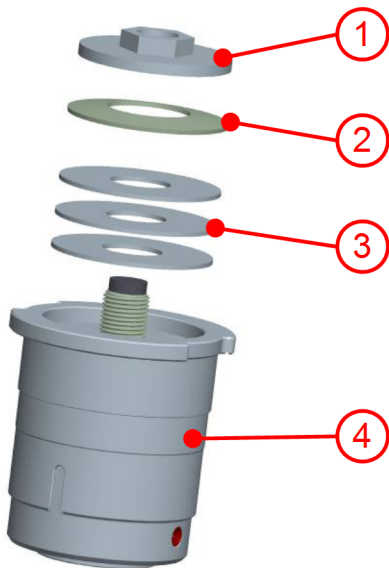

- 1 Lock nut
- 2 Rubber washer
- 3 Counterweights, 25 g each
- 4 Bowl counterweight

6.5.2 Handling

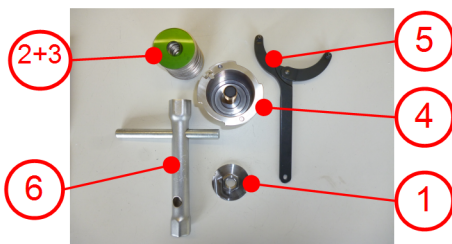

- 1 Lock nut
- 2 Rubber disk
- 3 Compensating washers, 25g each
- 4 Counterweight
- 5 2-hole face wrench
- 6 Pipe wrench

1. → Determine the weight of the grinding bowl to be used with lid, material to be ground and balls.

2. → Then, weigh the counterweight (4) and fit compensating washers (3) until the complete weight (with rubber disk (2) and lock nut (1)) of the complete counterweight matches the weight of the completely filled grinding bowl. (+/-12.5g)

3. → The spring must be pressed to be able to insert the washers.



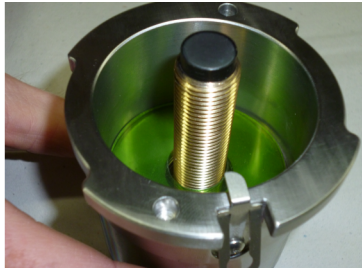

4. → Make sure that the green rubber disk (2) is lying at the top.

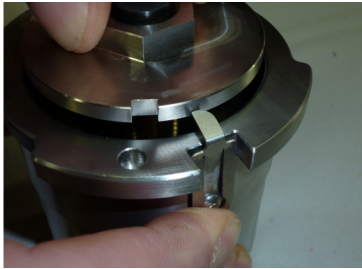

5. → Now turn the lock nut (1) onto the threaded spindle. To do this, push the spring back.

! NOTICE

Before starting the grinding process, ensure that the spring is not bent and that a lock nut, that may be loosening, is held by it in the bowl.

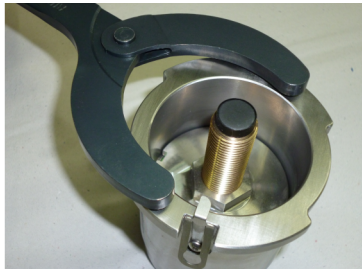

6. → Turn the lock nut (1) by hand until it touches the rubber disk (2).

7. → Now, insert the 2-hole face wrench (5) in the 2 bore holes of the bowl.

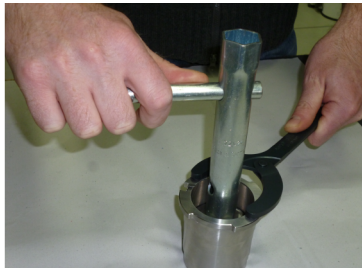

8. → Tighten the lock nut (1) very firmly using the pipe wrench (6).

! CAUTION

Check after the first 5 minutes of grinding if the lock nut has been released. If that is the case, it must be firmly re-tightened.

6.6 Planetary mills - "MillControl" software



The P-7 premium Planetary Mill is controlled either at the device using the clearly arranged touch display or with the MillControl software. The software provides the user with all device controlling options and adds further aspects to the operation of the planetary ball mills, like the conduction of identical grinding cycles, but also grinding operations using the SOPs. In addition, you also have the option of having your grinding operations evaluated in detail in standardised reports with the relevant parameters. If an EASY-GTM system is used, all important data of this system can be displayed in the program.

Detailed information on the "MillControl" software is available in the corresponding software manual.

6.7 Single-use grinding containers



The single-use technology is used for homogenization and resuspending.

! NOTICE

All containers have to be employed even if they are not filled.



- The grinding bowl made of stainless steel is filled with 6 x 1.5 ml sample bottles. If a second bowl is employed, you can increase the volume to 12 x 1.5 ml.
- If only one bowl is employed, use the counterweight on the opposite side. (Order no. 50.9890.00)
- The minimum filling amount of the sample bottles is 50 % of the volume.
- Only water may be used as a fluid.
- The fluid phase should feature a viscosity of about 600 mm²/s at 20° to achieve the desired result.
- ZrO₂ balls with a diameter of up to 2 mm may be employed. The maximum ball filling amount is 1/3 of the volume.
- The maximum running duration with balls is 1 minute; without balls 5 minutes!
- The maximum speed is at 800 rpm.
- After every interval, the condition of the containers needs to be checked.

7 General and optional settings

7.1 Standard Operation Procedure

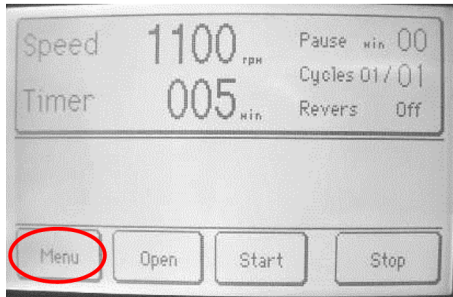

It is possible to protect this device by applying SOP mode. If this mode is activated by the administrator, only stored programs can be loaded for operation. Parameters can no longer be changed. Some parts of the menu structure can no longer be selected.

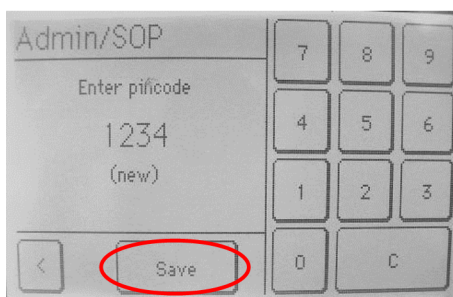
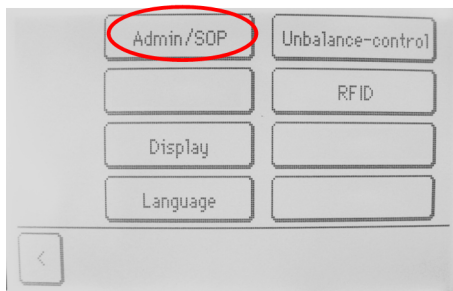
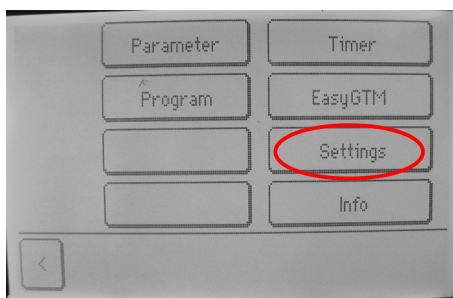



7.1.1 Activating SOP mode

1. Enter a number between 1 and 9999;
2. Then "Save" it;
3. Press the "<" button to return to the main menu.
 - ➔ SOP mode is displayed in the main menu.

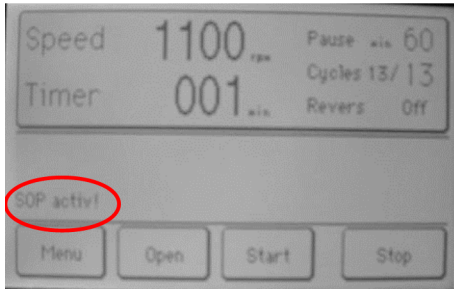

7.1.2 Deactivating SOP mode

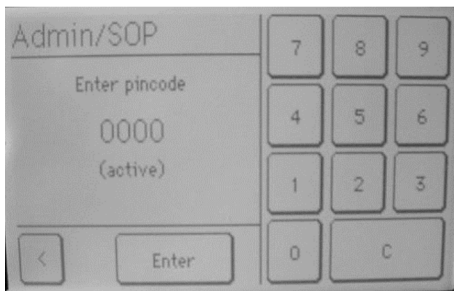

To disable the restrictions for changing parameters, enter the pin code and press the "ENTER" button. Press the "<" button to return to the main menu.

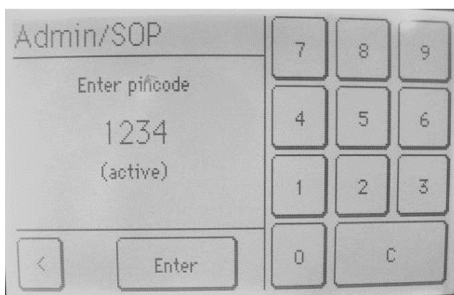

If the device is switched off, SOP mode is active again.

7.1.3 Deleting SOP mode

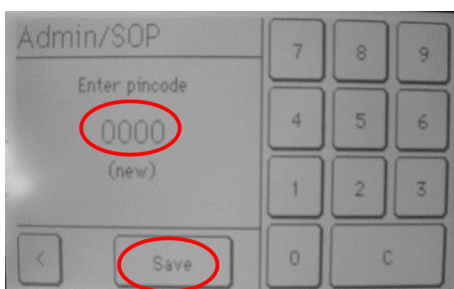

1. Deactivate the mode (➔ *Chapter 7.1.2 'Deactivating SOP mode' on page 86*)
2. Enter pin code 0000 and "Save" it
3. Press the "<" button to return to the main menu.

General and optional settings

7.2 RFID

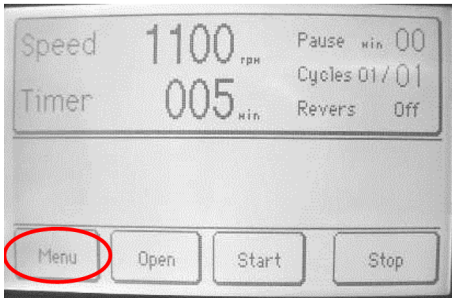

If the bowl is damaged, the bowl detection can be deactivated.

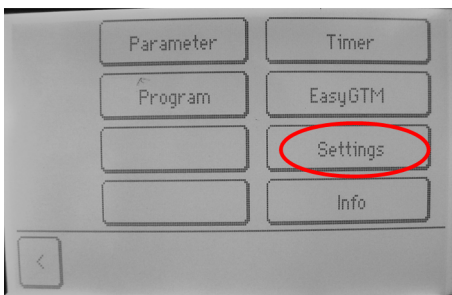

Because the RFID detection is a safety system that cannot simply be deactivated, it is protected by a pin code.

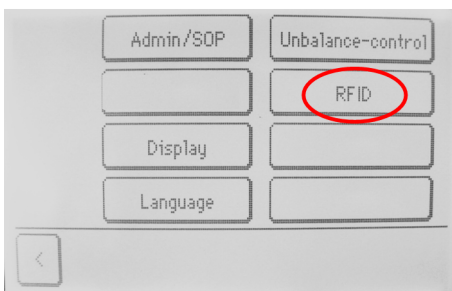

This pin code can only be obtained by consulting Fritsch GmbH.

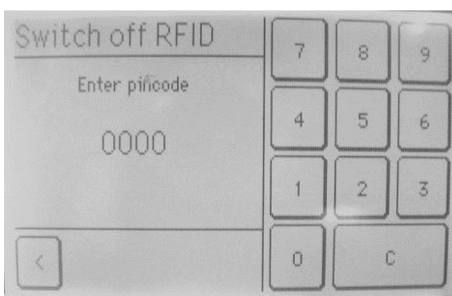



7.3 Language change

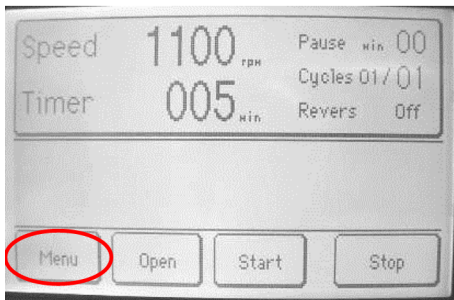

After selecting the national language, all other texts are displayed in the selected language.

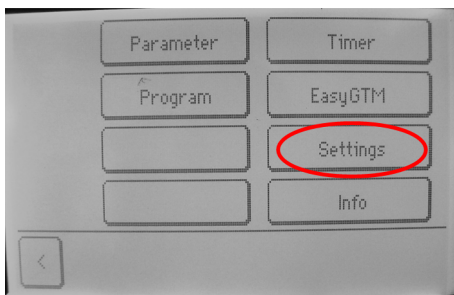

Press the "<" button to confirm your entry and return to the main menu.

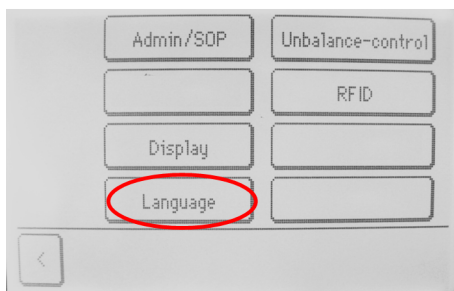

General and optional settings

7.4 Screen brightness

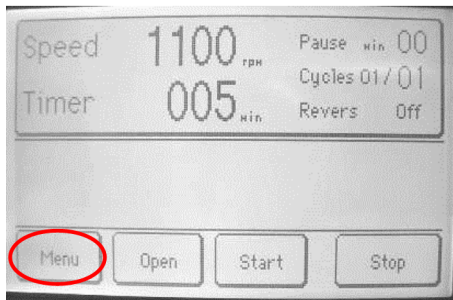

The screen's brightness can be adjusted individually. To do this, touch the adjustment bar or move it back and forth by applying slight pressure.

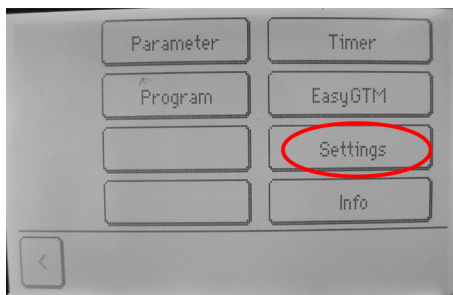

Press the "<" button to save your entry and return to the main menu.

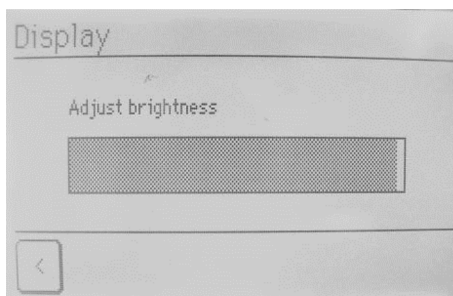



7.5 Information

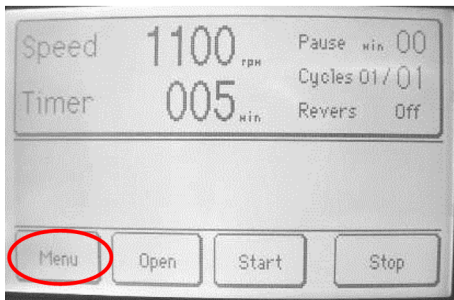

The "INFO" button can be pressed to access system information.

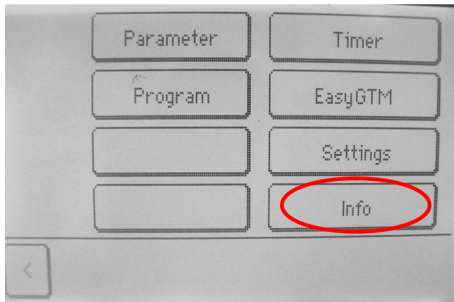

The

- operating hours,
- the firmware version and
- the bowl materials are displayed here (if they were detected during a START procedure).
- Press the "<" button to return to the main menu.

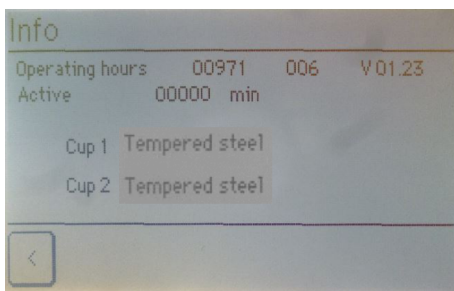

7.6 Firmware update

1. → Switch off the device.
2. → Install the USB driver software "PL-2303 Driver Installer.exe" on the PC / notebook.
3. → Connect the USB cable and only then switch on the device. The USB port is now automatically activated.
4. → Start the 'PROGRAMMER.EXE' software and then select the firmware file for programming.

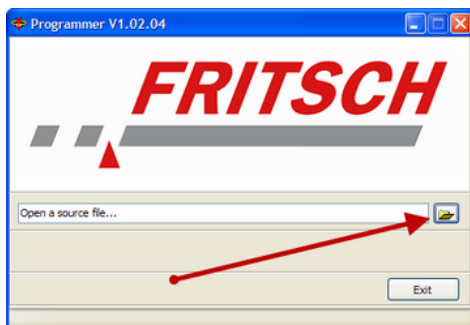

General and optional settings

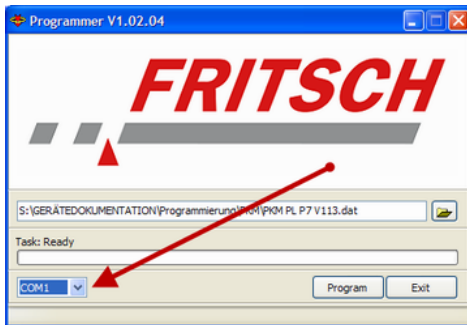

5. Select the newly installed COM port here

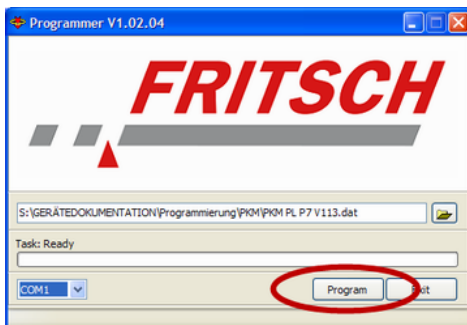

6. Press 'Program' to start the update.

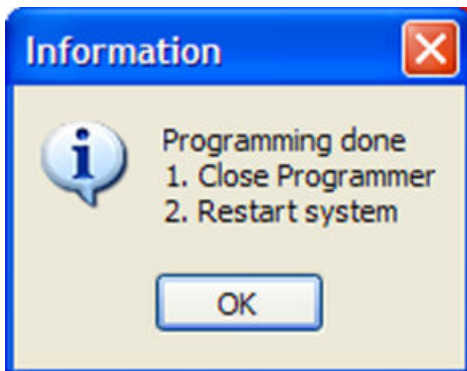

7. After programming

8. Now, connect the flasher software.

9. Switch off the planetary micro mill (not the computer!) for a few seconds.

10. Switch the device back on again

➔ Finished!!



8 Cleaning

8.1 Grinding elements

Clean the grinding bowl and grinding balls each time after using them: e.g. clean them under running water using a brush and a commercially available cleaning agent.

Fill the grinding bowl about halfway with some sand and water and run it for 2 to 3 minutes in the Laboratory Planetary Mill at maximum speed.

Cleaning with an ultrasonic cleaner is permitted.

For sterilisation in the heat cabinet, only heat the grinding elements up to 120°C.

Grinding elements made of agate may only be heated up to 100°C.

CAUTION

Cool grinding elements made of agate, sintered corundum, zirconium oxide and silicon nitride slowly and carefully.

Do not heat the grinding elements in a microwave under any circumstances (heating is too fast).

They must never be exposed to thermal shocks as this could cause irreparable damage to the parts → They will fall apart in an explosive manner.

8.2 Mill

DANGER



Mains voltage!

- Before beginning with cleaning work, disconnect the mains plug and protect the device against being unintentionally switched back on!
- Do not allow any liquids to flow into the device.
- Indicate cleaning work with warning signs.
- Put safety equipment back into operation after cleaning work.

The micro mill can be wiped down with a damp cloth when it is switched off.

The grinding chamber can be cleaned thoroughly with a damp cloth by removing the grinding chamber cover.

8.2.1 Removing the grinding chamber cover



1.  Remove the 4 screws from the side of the housing using a screwdriver.



2. → Then, carefully tilt the grinding chamber cover to the right.
3. → 3 connectors now need to be released.

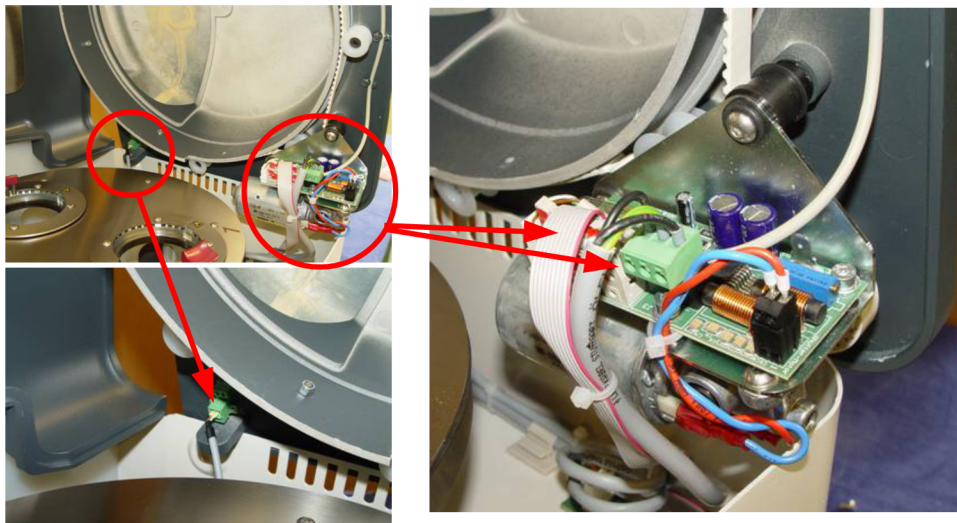

4. → After doing this, the cover can be lifted off completely and the grinding chamber can be cleaned.
5. → To fit the grinding chamber cover, proceed in the reverse order.

⚠ DANGER

Do not allow any liquids to flow into the device.



9 Maintenance

 **DANGER**



Mains voltage!

- Maintenance work may only be performed by specialised personnel.
- Before beginning with maintenance work, unplug the mains plug and protect the device against being unintentionally switched back on.
- Put safety equipment back into operation after maintenance work.
- Indicate maintenance work with warning signs.



We recommend keeping a safety logbook → Chapter 12 'Safety logbook' on page 99, where all work (maintenance, repairs.....) performed on the device is entered.



The most important element of maintenance is regular cleaning!

10 Guarantee terms

Guarantee period

As manufacturer, FRITSCH GmbH provides – above and beyond any guarantee claims against the seller – a guaranty valid for the duration of two years from the date of issue of the guarantee certificate supplied with the device.

Within this guarantee period, we shall remedy all deficiencies due to material or manufacturing defects free of charge. Rectification may take the form of either repair or replacement of the device, at our sole discretion. The guarantee may be redeemed in all countries in which this FRITSCH device is sold with our authorisation.

Conditions for claims against the guarantee

This guarantee is subject to the condition that the device is operated according to the instructions for use / operating manual and its intended use.

Claims against the guarantee must include presentation of the original receipt, stating the date of purchase and name of the dealer, together with the complete device type and serial number.

Reasons for loss of the guarantee

The guarantee will not be granted in cases where:

- Damage has arisen due to normal wear and tear, especially for wear parts, such as: Crushing jaws, support walls, grinding bowls, grinding balls, sieve plates, brush strips, grinding sets, grinding disks, rotors, sieve rings, pin inserts, conversion kits, sieve inserts, bottom sieves, grinding inserts, cutting tools, sieve cassettes, sieve and measuring cell glasses.
- Repairs, adaptations or modifications were made to the device by unauthorized persons or companies.
- The device was not used in a laboratory environment and/or has been used in continuous operation.
- Damage is present due to external factors (lightning, water, fire or similar) or improper handling.
- Damage is present that only insubstantially affects the value or proper functioning of the device.
- The device type or serial number on the device has been changed, deleted, removed or in any other way rendered illegible
- The above-mentioned documents have been changed in any way or rendered illegible.

Costs not covered by the guarantee

This guarantee excludes any costs for transport, packaging or travel that accrue in the event the product must be sent to us or in the event that one of our specialist technicians is required to come to your site. Any servicing done by persons not authorised by us and any use of parts that are not original FRITSCH accessories and spare parts will void the guarantee.

Further information about the guarantee

The guarantee period will neither extend nor will a new period of guarantee begin in the event that a claim is placed against the guarantee.



Please provide a detailed description of the type of error or the complaint. If no error description is enclosed, we shall interpret the shipment as an assignment to remedy all recognisable errors or faults, including those not covered by the guarantee. Errors or faults not covered by the guarantee shall in this case be rectified at cost.

We recommend reading the operating manual before contacting us or your dealer, in order to avoid unnecessary inconvenience.

Ownership of defective parts is transferred to us with the delivery of the replacement part; the defective part shall be returned to us at buyer's expense.

! NOTICE

Please note that in the event that the device must be returned, the device must be shipped in the original Fritsch packaging. Fritsch GmbH denies all liability for any damage due to improper packaging (packaging not from Fritsch).

Any enquiries must include a reference to the serial number imprinted on the type plate.

11 Exclusion of liability

Before using the product, be sure to have read and understood this operating manual.

The use of the product requires technical knowledge; only commercial use is permitted.

The product may be used exclusively within the scope of applications set down in this operating manual and within the framework of guidelines put forth in this operating manual and must be subject to regular maintenance. In case of non-compliance, improper use or improper maintenance, the customer assumes full liability for the functional capability of the product and for damage or injury arising from violating these obligations.

The contents of this operating manual are subject in entirety to copyright law. This operating manual and its contents may not be copied, further distributed or stored in any form, in part or in whole, without the prior written consent of Fritsch.

This operating manual has been prepared to the best of our knowledge and checked for accuracy at the time of printing. FRITSCH GMBH assumes no guarantee or liability whatsoever for the accuracy or completeness of the contents of this operating manual, including but not limited to the implied warranties of merchantability and fitness for a particular purpose, unless liability is expressly prescribed by applicable laws or jurisprudence.

FRITSCH GMBH expressly reserves the right to modify and/or update this operating manual without prior notice. The same applies to modifications and improvements to the products described in this operating manual. It is the responsibility of the user to ensure that they have the current version of this operating manual. For more information, please contact your local FRITSCH GMBH distributor or Fritsch GmbH, Industriestr. 8, D-55473 Idar-Oberstein.

Not all parts shown here are necessarily installed in the product. The buyer is not entitled to delivery of these parts. If interested, please contact your local FRITSCH GMBH distributor or Fritsch GmbH, Industriestr. 8, D-55473 Idar-Oberstein.

FRITSCH GMBH takes the greatest care to ensure that the quality, reliability and safety of your products are continuously improved and adapted to the state of the art. The supplied products as well as this operating manual conform to the current state of the art when they leave the sphere of influence of FRITSCH GMBH.

By using the product the customer agrees with this and recognizes that defects, malfunctions or errors cannot be completely excluded. To prevent risk of damage to persons or property or of other direct or indirect damage, resulting from this or other causes, the customer must implement sufficient and comprehensive safety measures for working with the product.

Fritsch GmbH excludes any liability, warranty, or other obligation to compensate for damages, regardless of whether this liability, warranty, or other obligation is explicit or implicit, contractual or arising from unlawful acts or prescribed contractually, by law, or otherwise. In no event shall the buyer be entitled to any compensation from Fritsch GmbH for any special, direct, indirect, coincidental or consequential damage, including but not limited to lost profits, lost savings, lost sales or financial loss of any kind or for compensation of third parties, for downtimes, for lost goodwill, for damage to or replacement of equipment and property, for costs or restoration of materials or goods related to the product or the use of our products, for other damage



or injury to persons (including fatal injuries) or similar. The above exclusion of liability is limited by mandatory liability as prescribed by laws or jurisprudence. Liability for negligence is excluded in all cases.

No permission is given expressly, implicitly or otherwise for the use of patents, brands or other copyrights. We also assume no liability for copyright infringements or infringements of the rights of third parties arising from the use of this product.

Neither compliance with this operating manual nor the conditions and methods used during installation, operation, use and maintenance of the product can be monitored by Fritsch GmbH. Improper execution of the installation can result in property damage and thus endanger persons. Therefore, we assume absolutely no responsibility or liability for loss, damage or costs that result from errors at installation, improper operation or improper use or improper maintenance or are in any way connected to these.



© 2022

Fritsch GmbH

Industriestraße 8

D - 55743 Idar-Oberstein

Telephone: +49 6784 70-0

Email: info@fritsch.de

Internet: www.fritsch.de