

P-5 *premium*

PLANETARY MILL

READ THE INSTRUCTIONS PRIOR TO PERFORMING ANY TASK!



Valid from: 05.70X0/00001

Translation of the original operating instructions

Version 01/2026 Index 017



1	Basic structure.	6
2	Safety information and use.	7
2.1	Requirements for the user.	7
2.2	Scope of application.	8
2.2.1	Operating principle.	8
2.2.2	Drive motor and speed regulation.	9
2.3	Obligations of the operator.	9
2.4	Information on hazards and symbols used in this manual.	10
2.5	Device safety information.	11
2.6	Protective equipment.	12
2.6.1	Imbalance check.	13
2.7	Hazardous points.	13
2.8	Electrical safety.	14
2.8.1	General information.	14
2.8.2	Protection against restart.	14
2.8.3	Overload protection.	14
2.8.4	Imbalance detection.	14
2.8.5	Operation on GFCI (Ground-Fault Circuit Interrupters).	14
3	Technical data.	15
3.1	Dimensions.	15
3.2	Weight.	15
3.3	Operating noise.	15
3.4	Voltage.	15
3.5	Current consumption.	15
3.6	Power consumption.	16
3.7	Protection class.	16
3.8	Electrical fuses.	16
3.9	Material.	16
3.10	Final fineness.	16
4	Installation.	17
4.1	Transport.	17
4.2	Unpacking.	17
4.3	Setting up.	17
4.3.1	Balancing out the installation surface.	18
4.4	Ambient conditions.	19
4.5	Prepare power cord.	19
4.6	Electrical connection.	23
5	Initial start-up.	24
5.1	Switching on.	24
5.2	Function check.	24

6	Using the device.	25
6.1	General information.	25
6.2	Choice of grinding bowls and grinding balls.	25
6.2.1	Size of the grinding balls.	26
6.2.2	Recommended number of balls per grinding bowl (independent of the material quantity).	27
6.2.3	Average calculated weight of a ball.	28
6.3	Filling the grinding bowl.	29
6.3.1	Closing the grinding bowl.	29
6.4	Settings on the control panel.	29
6.4.1	Menu.	30
6.4.2	Bowl.	31
6.5	Clamping the grinding bowls.	31
6.5.1	Clamping the 125 ml / 150 ml grinding bowls.	32
6.6	Mass balance.	33
6.7	Factors with an impact on grinding.	33
6.7.1	Running time (grinding duration).	33
6.7.2	Speed.	35
6.7.3	Reverse mode.	35
6.7.4	Number and size of the balls.	36
6.7.5	Weight of the balls (type of material).	36
6.7.6	Dry grinding.	36
6.7.7	Wet grinding (grinding in a suspension).	37
6.8	Conducting a grinding operation.	38
6.8.1	Overload.	38
6.8.2	Switching off.	39
6.9	Cooling the grinding bowl.	39
6.10	Removing the grinding bowls.	40
6.10.1	'Opening the clamping device'.	40
6.10.2	Removing the grinding bowl.	41
6.11	Special emptying device for grinding bowls.	42
7	Accessories.	43
7.1	Planetary mills - "MillControl" software.	43
7.2	Gas Pressure and Temperature Measuring System.	43
7.2.1	Case contents and system design.	44
7.2.2	Inserting / changing the battery.	44
7.2.3	Configuration of transmitter ID and data transmission frequency. .	47
7.2.4	Installation of the transmission unit on the EASY-GTM bowl.	48
7.2.5	Installation of the receiver board in the P-5 premium.	49
7.2.6	Entering the temperature limit.	50



7.2.7	Entering the pressure limit.	51
7.2.8	Selecting the operating mode.	51
7.2.9	Cleaning the EASY-GTM system.	51
7.3	Grinding in inert gas with gassing lid or screw-on lid.	53
7.3.1	Mounting the screw-on lid on the grinding bowl.	53
7.3.2	Preparation for gassing.	54
7.3.3	Gassing.	54
7.3.4	Ventilate after grinding.	54
7.3.5	Cleaning the valves.	55
7.4	Compl. counterweight.	55
7.4.1	Design.	55
7.4.2	Handling.	56
7.5	Single-use grinding containers.	56
7.6	Optional accessories.	58
8	Cleaning.	61
8.1	Grinding elements.	61
8.2	Device.	61
9	Maintenance.	62
10	Disposal.	63
11	Guarantee terms.	64
12	Exclusion of liability.	66
13	Safety logbook.	68

Certification and CE conformity

Certification

Fritsch GmbH has been certified by TÜV Saarland Certification GmbH.



An audit has proven that Fritsch GmbH meets the requirements of DIN EN ISO 9001:2015 and DIN EN ISO 14001:2015.

CE conformity

The enclosed conformity declaration lists the guidelines to which the FRITSCH instrument conforms in order to bear the CE mark.





1 Basic structure



- 1 Hood
- 2 ServoLOCK grinding bowl clamping device with visor
- 3 Grinding bowl
- 4 RFID bowl detection unit
- 5 Adjustable control panel
- 6 Main switch

2 Safety information and use

2.1 Requirements for the user

This operating manual is intended for persons assigned with operating and monitoring the Fritsch P-5 premium. The operating manual and especially its safety instructions are to be observed by all persons working on or with this device. In addition, the applicable rules and regulations for accident prevention at the installation site are to be observed. Always keep the operating manual at the installation site of the P-5 premium.

People with health problems or under the influence of medication, drugs, alcohol or exhaustion must not operate this device.

The P-5 premium may only be operated by authorised persons and serviced or repaired by trained specialists. All commissioning, maintenance and repair work may only be carried out by technically qualified personnel. Qualified personnel are persons who, because of their education, experience and training as well as their knowledge of relevant standards, regulations, accident prevention guidelines and operating conditions, are authorised by those responsible for the safety of the machine to carry out the required work and are able to recognize and avoid possible hazards as defined for skilled workers in IEC 364.

In order to prevent hazards to users, follow the instructions in this manual.

Malfunctions that impair the safety of persons, the P-5 premium or other material property must be rectified immediately. The following information serves both the personal safety of operating personnel as well as the safety of the products described and any devices connected to them: All maintenance and repair work may only be performed by technically qualified personnel.

This operating manual is not a complete technical description. Only the details required for operation and maintaining usability are described.

Fritsch has prepared and reviewed this operating manual with the greatest care. However, no guarantee is made for its completeness or accuracy.

Subject to technical modifications.



2.2 Scope of application

! NOTICE

Fritsch laboratory mills are not intended for use in explosion-hazardous areas. Fritsch laboratory mills therefore fall outside the scope of the 94/9/EC Directive, but within the scope of the Machinery Directive 2006/42/EC. The use of Fritsch laboratory mills within explosion-hazardous areas is not permissible according to ATEX (94/9/EC) and is only allowed if additional explosion protection measures are taken. According to the Machinery Directive 2006/42/EC, there are no ignition sources in our mills that can become effective during normal operation. Nonetheless, there may be ignition sources in our mills that may become effective in the event of probable malfunctions.

Because Fritsch has only limited information on the composition of the ground product in use, its final fineness and therefore ultimately its ignition temperature, no statement regarding the explosion risk during intended use in conjunction with the occurring energy input can be made.

The occurrence of dust explosions can therefore never be completely ruled out. The user must create an explosion protection document in accordance with the ATEX 137 Directive (1999/92/EC) and define appropriate protective measures.

! NOTICE

This laboratory instrument is designed for an 8-hour shift operation at 30 % duty cycle and not for continuous operation.

The duty cycle is defined as the ratio of load duration to run time. The run time is defined as load duration plus pause time. According to DIN EN 60034-1 (VDE 0530, IEC34-1) a continuous operation already takes place after a standardised run time of 10 minutes. At 30 % duty cycle (DC = ratio of load duration to run time) a load duration of 3 minutes and a pause time of 7 minutes would be within standard.

If the standardised run time of 10 minutes is exceeded, then, by definition, there would be a continuous operation and disproportionate temperature increases may occur, possibly involving increased wear.

The Planetary Mill P-5 premium can be applied universally for the fast, dry or wet grinding of inorganic and organic samples for analysis, quality inspection, material testing or mechanical alloying. During synthesis, the P-5 premium mixes and homogenises dry samples, emulsions or suspensions.

2.2.1 Operating principle

The grinding stock is crushed and ground by grinding balls in a grinding bowl. The centrifugal forces from the rotation of the grinding bowls around their own axis and from the rotating support disc act on the contents of the grinding bowl which consists of grinding stock and grinding balls.

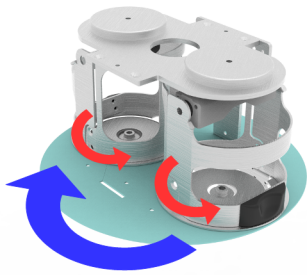

The grinding bowl and the support disc have opposite directions of rotation, so that the centrifugal forces alternate in the same direction and in the opposite direction. The result is that the grinding balls run down the inside of the bowl's wall providing a friction effect and the grinding balls hit the opposite wall of the grinding bowl providing an impact effect. The impact effect is amplified by the impact of the grinding balls against each other.

The loss-free comminution, even when grinding suspensions, is ensured by the hermetic seal between the grinding bowl and the lid.

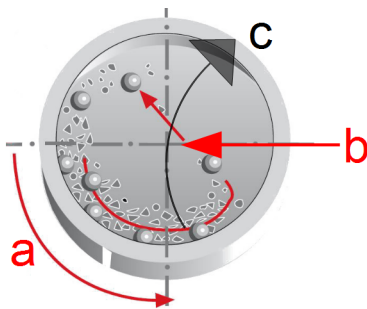

- a Rotation of the grinding bowl
- b Centrifugal force from the rotation of the support
- c Support disc movement

2.2.2 Drive motor and speed regulation

A maintenance-free three-phase motor operated via a frequency converter is used as the drive.

2.3 Obligations of the operator

Before using the P-5 premium, this manual is to be carefully read and understood. The use of the P-5 premium requires technical knowledge; only commercial use is permitted.

The operating personnel must be familiar with the content of the operating manual. For this reason, it is very important that these persons actually receive the present operating manual. Ensure that the operating manual is always near the device.

The P-5 premium may exclusively be used within the scope of applications set down in this manual and within the framework of guidelines put forth in this manual. In case of non-compliance or improper use, the customer assumes full liability for the functional capability of the P-5 premium and for any damage or injury arising from failure to fulfil this obligation.

By using the P-5 premium the customer agrees with this and recognizes that defects, malfunctions or errors cannot be completely excluded. To prevent risk of damage to persons or property or of other direct or indirect damage, resulting from this or other causes, the customer must implement sufficient and comprehensive safety measures for working with the P-5 premium.

Neither compliance with this manual nor the conditions and methods used during installation, operation, use and maintenance of the P-5 premium can be monitored by Fritsch GmbH. Improper execution of the installation can result in property damage and thus endanger persons. Therefore, we assume absolutely no responsibility or liability for loss, damage or costs that result from errors at installation, improper operation or improper use or improper maintenance or are in any way connected to these.

The applicable accident prevention guidelines must be complied with.



Generally applicable legal and other obligatory regulations regarding environmental protection must be observed.

2.4 Information on hazards and symbols used in this manual

Safety information

Safety information in this manual is designated by symbols. Safety information is introduced by keywords that express the extent of the hazard.

DANGER

This symbol and keyword combination points out a directly hazardous situation that can result in death or serious injury if not avoided.

WARNING

This symbol and keyword combination points out a possibly hazardous situation that can result in death or serious injury if not avoided.

CAUTION

This symbol and keyword combination points out a possibly hazardous situation that can result in slight or minor injury if not avoided.

NOTICE

This symbol and keyword combination points out a possibly hazardous situation that can result in property damage if not avoided.

Special safety information

To call attention to specific hazards, the following symbols are used in the safety information:

DANGER



This symbol and keyword combination points out a directly hazardous situation due to electrical current. Ignoring information with this designation will result in serious or fatal injury.

DANGER





This symbol and keyword combination designates contents and instructions for proper use of the machine in explosive areas or with explosive substances. Ignoring information with this designation will result in serious or fatal injury.

DANGER



This symbol and keyword combination designates contents and instructions for proper use of the machine with combustible substances. Ignoring information with this designation will result in serious or fatal injury.

 **WARNING**

 This symbol and keyword combination points out a directly hazardous situation due to movable parts. Ignoring information with this designation can result in hand injuries.

 **WARNING**

 This symbol and keyword combination points out a directly hazardous situation due to hot surfaces. Ignoring information with this designation can result in serious burn injuries due to skin contact with hot surfaces.

Safety information in the procedure instructions

Safety information can refer to specific, individual procedure instructions. Such safety information is embedded in the procedure instructions so that the text can be read without interruption as the procedure is being carried out. The keywords described above are used.

Example:

1. → Loosen screw.

2. →

 **CAUTION**

Risk of entrapment at the lid.

Close the lid carefully.

3. → Tighten screw.

Tips and recommendations

 *This symbol emphasises useful tips and recommendations as well as information for efficient operation without malfunction.*

2.5 Device safety information

Please observe!

- Only use original accessories and original spare parts. Failure to observe this instruction can compromise the safety of the machine.
- Safe conduct must be strictly observed during all work.
- All currently applicable national and international accident prevention guidelines must be complied with.



 **CAUTION**

Wear hearing protection!

If a noise level of 85 dB(A) is reached or exceeded, ear protection should be worn to prevent hearing damage.



WARNING

The maximum accepted concentration (MAC) levels of the valid safety regulations must be observed. If necessary, ventilation must be provided or the machine must be operated under an extractor hood.

DANGER



Explosion hazard!

- When Grinding oxidisable substances, e.g. metal or coal, there is a risk of spontaneous combustion (dust explosion) if the proportion of fine particles exceeds a certain percentage. When Grinding these kinds of substances, special safety measures must be taken and the work must be supervised by a specialist.
- The device is not explosion-protected and is not suitable for Grinding explosive materials.

NOTICE

Immediately replace damaged or illegible information signs.

- Do not remove the information signs.
- Unauthorised alteration of the device will void Fritsch's declaration of conformity to European directives and void the guarantee.
- The P-5 premium should only be used when it is in proper working order, as intended and in a safety- and hazard-conscious manner adhering to the operating manual. In particular, immediately rectify any malfunctions that could pose a safety hazard.
- If, after reading the operating manual, there are still questions or problems, please do not hesitate to contact our specialised personnel.
- Do not reuse damaged accessories.
- With certain materials, do not leave the Planetary Mill running for several minutes without a cooling phase. Risk of overheating!
- The mill must never be left running unsupervised. In certain operating states, the vibrations may result in a shifting effect on the surface.

2.6 Protective equipment



Protective equipment is to be used as intended and may not be disabled or removed.

All protective equipment is to be regularly checked for integrity and proper functioning.

- Detection of whether bowls are clamped at both positions.
- Detection of whether the visor is closed. Status is indicated via LED in the bowl detection unit.
- If the visor is open, the main disk is mechanically blocked.
- RFID detection of bowl material.
- The hood (1) must be closed before start-up, otherwise the main disk is mechanically blocked.

- When changing the position of the grinding bowl stations, the position number must be held down on the display until the position has been reached. This prevents further crushing injuries caused by reaching into the grinding chamber.
- Anti-crushing protection during closing of the grinding chamber hood.
- The ball size is queried at speeds greater than 400 rpm.

2.6.1 Imbalance check

If there is too much of a difference in weight between the grinding bowls containing the grinding balls and the sample, the device can become imbalanced and will shut off automatically. (See → Chapter 6.6 'Mass balance' on page 33).

! NOTICE

Change these settings only after all work as described in → Chapter 4.1 'Installation' on page 17 has been carried out!

! NOTICE

A medium level of sensitivity is set for the imbalance check as the factory default. In order to adjust the imbalance check to suit your applications as best as possible, set the value for the imbalance check as explained in Chapter → Chapter 6.4.1 'Menu' on page 30. Please note that you may have to redefine this setting for various parameters with different grinding sets and balls.

2.7 Hazardous points

! CAUTION

- Crushing hazard when closing the hood
- Crushing hazard at the grinding bowl clamping device
- Crushing hazard when exchanging the grinding disks



! CAUTION

Risk of splashing!

During wet grinding, the high temperature may have created overpressure.



! CAUTION

Burn hazard!

Grinding bowls can get very hot after long grinding durations. Wear protective gloves for removal after grinding or during the grinding breaks.



2.8 Electrical safety

2.8.1 General information

- The main switch (6) on the front of the device also functions as an emergency-off switch.
- The main switch (6) separates the device from the mains on two poles.
- Switch off the main switch (6) if the Planetary Mill will be idle for an extended period of time (e.g. overnight).

2.8.2 Protection against restart

If a power failure occurs during operation or if the device is switched off with the main switch (6), the hood (1) is locked. The hood remains closed when power returns.

2.8.3 Overload protection

- In the event of an overload, the device reduces the speed in a controlled manner.
- The device switches off if the drive is blocked.
- The device switches off if the drive motor becomes too hot.

2.8.4 Imbalance detection

The device switches off if there is excessive imbalance. (see ➔ *Chapter 6.6 'Mass balance'* on page 33 and ➔ *Chapter 2.6.1 'Imbalance check'* on page 13)

2.8.5 Operation on GFCI (Ground-Fault Circuit Interrupters)

It is possible that the leakage currents will become marginal during operation. This may trigger the earth leakage circuit breaker. These values can quickly be reached when all devices are added to the circuit.

Solution: Circuit without an earth leakage circuit breaker or, if possible, increase the earth leakage circuit breaker threshold.

3 Technical data

3.1 Dimensions

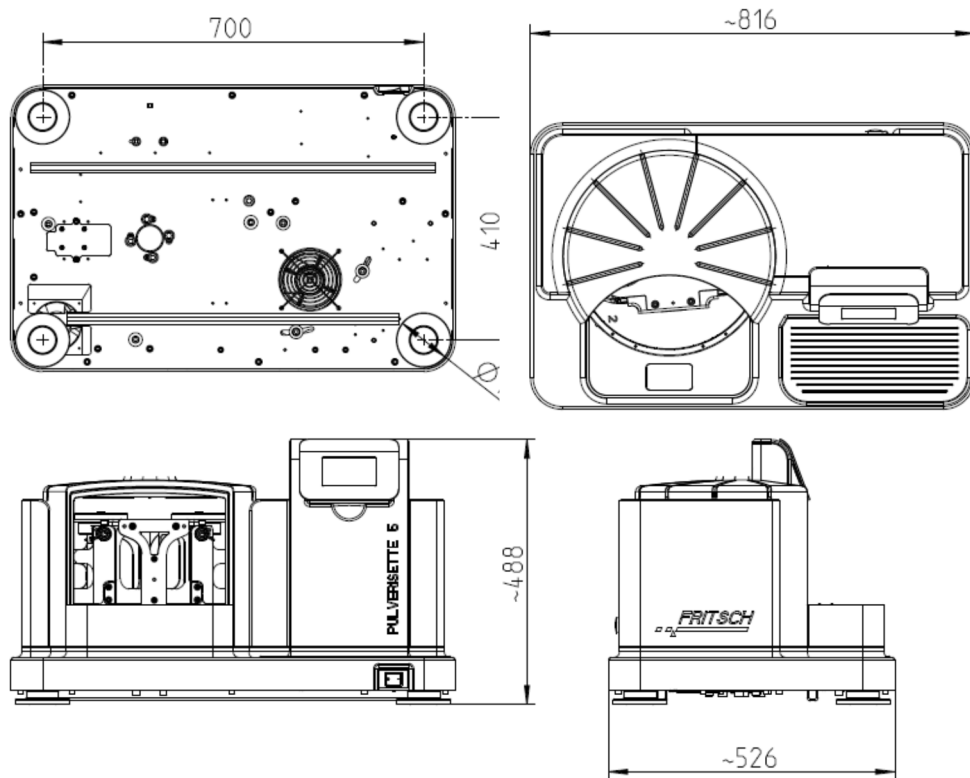

3.2 Weight

Net: 110 kg

3.3 Operating noise

The sound level is approx. 84 dB (A). This value fluctuates significantly, depending on the speed and material to be ground and on the type of grinding bowl and grinding balls.

3.4 Voltage

Single phase alternating current 200 - 240 V

Three-phase alternating current 200 - 230 V

3.5 Current consumption

■ 200 - 240 V → 16 AT



3.6 Power consumption

Depending on the voltage range, the maximum power consumption is approx. 2.5 W.

3.7 Protection class

IP 21

3.8 Electrical fuses

Fuse on the back of device:

2 x 16 AT

1 x 2,5 AT

3.9 Material

- Maximum feeding size approx. 15 mm
- Feed quantity 15 - 450 ml

3.10 Final fineness

- Dry grinding < 20 μm (depending on materials and parameters)
- Wet grinding < 0,05 μm (depending on materials and parameters)

4 Installation

4.1 Transport

The device is delivered on a transport pallet with a wooden cover. We recommend using a forklift or pallet truck for transporting the packed device.



! DANGER

Do not step under the transport pallet during transport.

! WARNING

Improper lifting can lead to personal injury or property damage. The machine is only to be lifted with suitable equipment and by qualified personnel.

The guarantee excludes all claims for damage due to improper transport.

4.2 Unpacking

- Pull out the nails that fasten the lid to the surrounding packaging.
- Remove the lid.
- Take out the accessories.
- Pull out the nails that fasten the surrounding packaging to the transport pallet.
- Then lift the wooden surround over and away from the device.
- Store the transport packaging so that it can be reused if you need to return the product. Fritsch GmbH accepts no liability for damage caused by improper packaging (packaging that is not from Fritsch).
- Compare the contents of the delivery with your order.



Grinding bowls made of tempered steel may have recesses on the surface caused during production. They do not have an impact on grinding or the grinding results and usually disappear after the first grinding operation.

These recesses on the surface, if present, are within the range of the permissible production tolerances. Complaints relating to such grinding bowls therefore cannot be accepted.

4.3 Setting up

! NOTICE

Allow the device to acclimatise for two hours before commissioning. High temperature differences can lead to condensation in the device and damage to the electronics after switching on.



Strong temperature fluctuations can occur during transport or interim storage. Depending on the temperature difference between the installation site and the transport or storage environment, condensation can form inside the device. This can damage the electronics if the devices are switched on too early. Wait for at least two hours after setup before switching on the device.



DANGER

Do not step under the transport pallet during transport.

CAUTION

The weight of the planetary mill is approx. 110 kg!

NOTICE

Never operate the mill while it is standing on the transport pallet!

NOTICE

Keep all air intake and ventilation slots clear to prevent the device from overheating.



- The mill must be lifted by 4 people on each corner on which loops are located and placed in its intended location.
- Place the mill on a flat, stable surface. It does not have to be fastened to the surface.
The mill can be placed on a stable table.
- Remove the hexagon screws that secure the loops. Keep the loops in case the unit must be transported again.

4.3.1 Balancing out the installation surface

You can adjust the front right foot to accommodate uneven installation surfaces. To do this, proceed as follows:

1. → Lift up the rubber work surface.
2. → Six Torx screws are located under it. Remove them.
3. → On the base plate you will see a nut that secures the adjustable foot. Loosen it and turn the foot in the direction that you want to adjust it.



If the adjustable foot is unscrewed too far, the P-5 premium must be lifted slightly by a second person and the foot must be screwed in.

4. → Once the height of the foot has been adjusted, re-tighten the nut.

Follow the following link to view a step-by-step instructional video for setting the front right foot. → [Click here.](#)



You can also view the video directly via our homepage on the product page of the device under 'Downloads - Service Videos' or on our YouTube channel 'FRITSCH Milling and Sizing'.

4.4 Ambient conditions



WARNING



Mains voltage

- The device may only be operated indoors.
- The surrounding air must not contain any electrically conductive particles.
- Maximum relative humidity 80% for temperatures up to 31 °C, linearly decreasing down to 50% relative humidity at 40 °C.

- The room temperature should be between 5 and 40 °C.
- Altitudes up to 2000 m
- Degree of pollution 2 according to IEC 60664-1:2007.

4.5 Prepare power cord



DANGER



Changes to the connection line may only be made by a qualified person.

The Planetary Mill requires a supply network with 200-240 V at a mains frequency of 50-60 Hz for proper operation. Setup the power cord as follows:

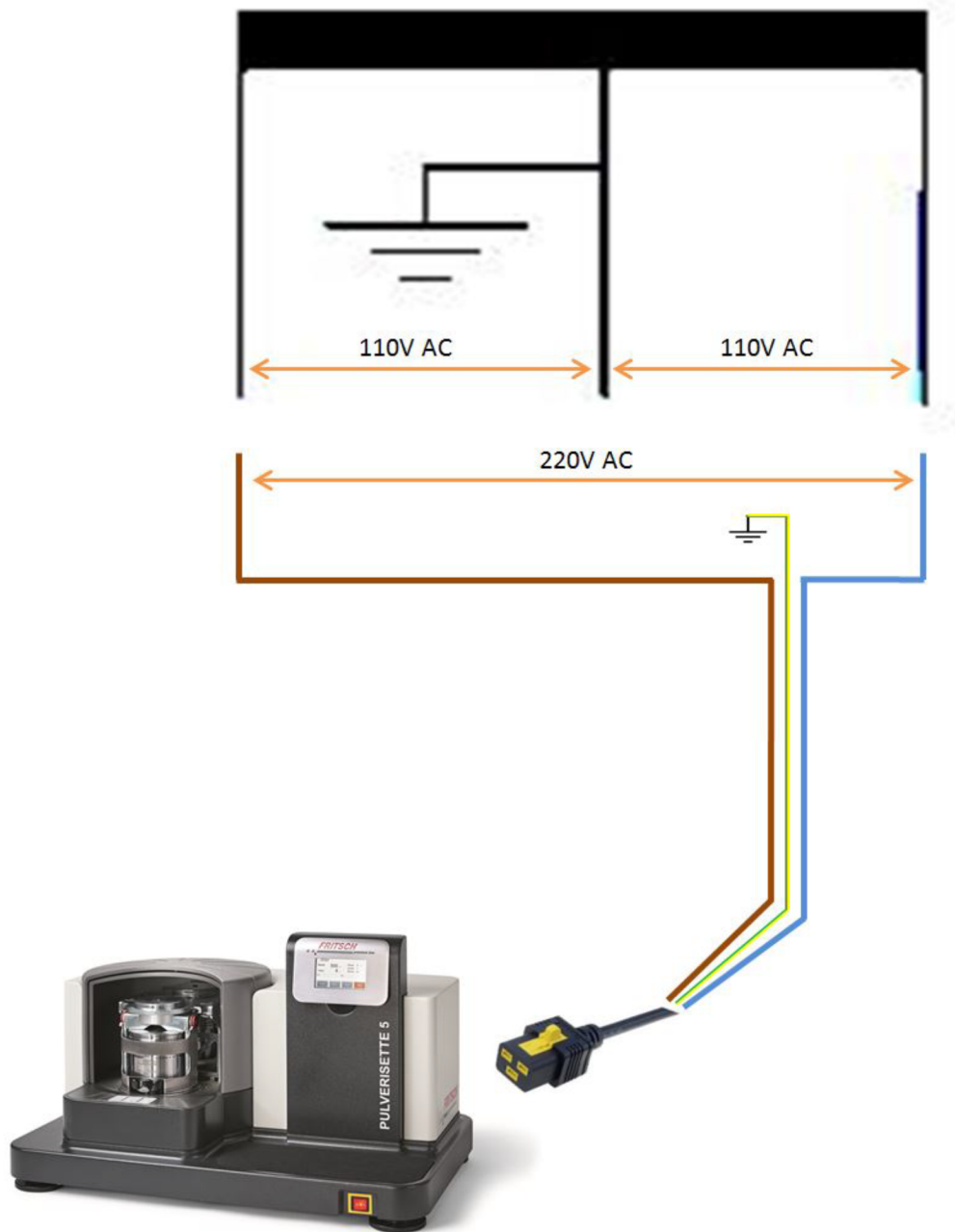

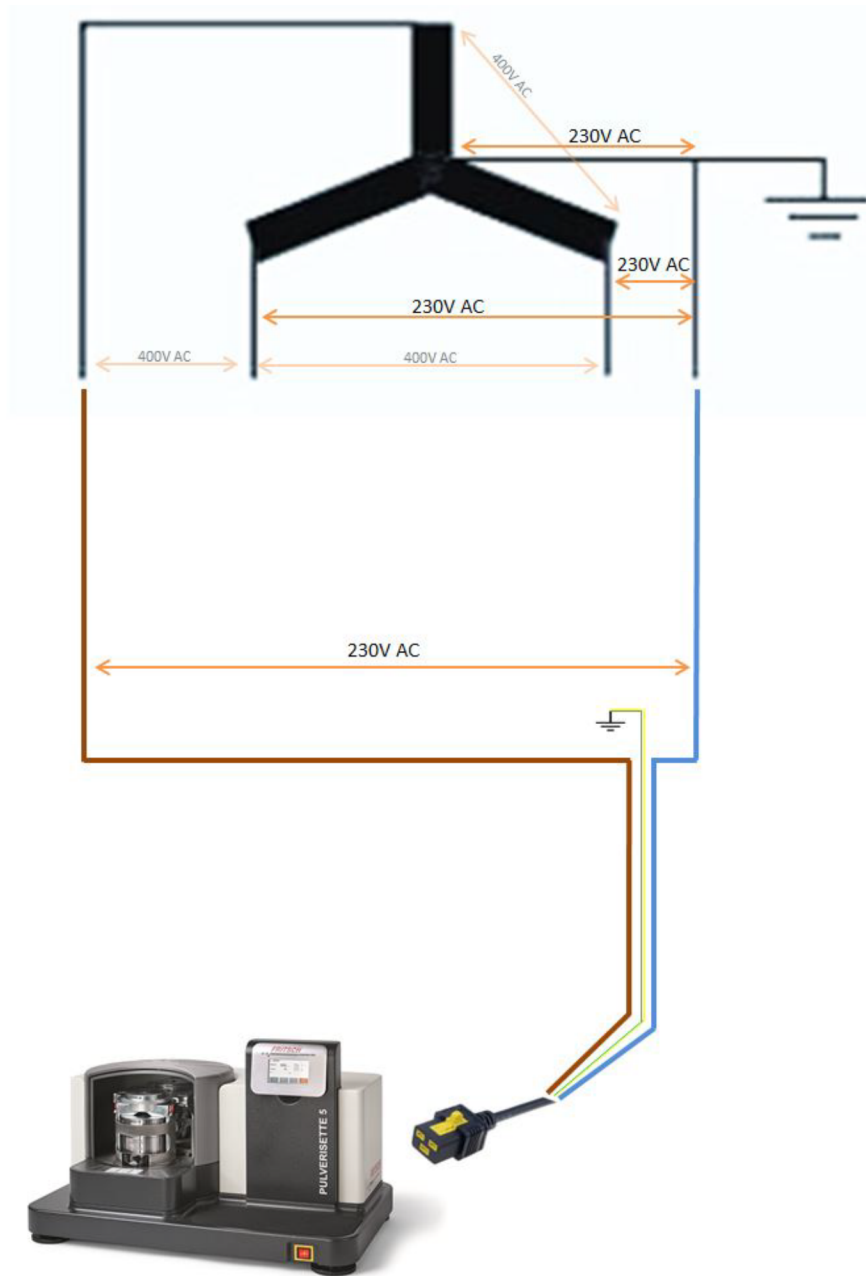

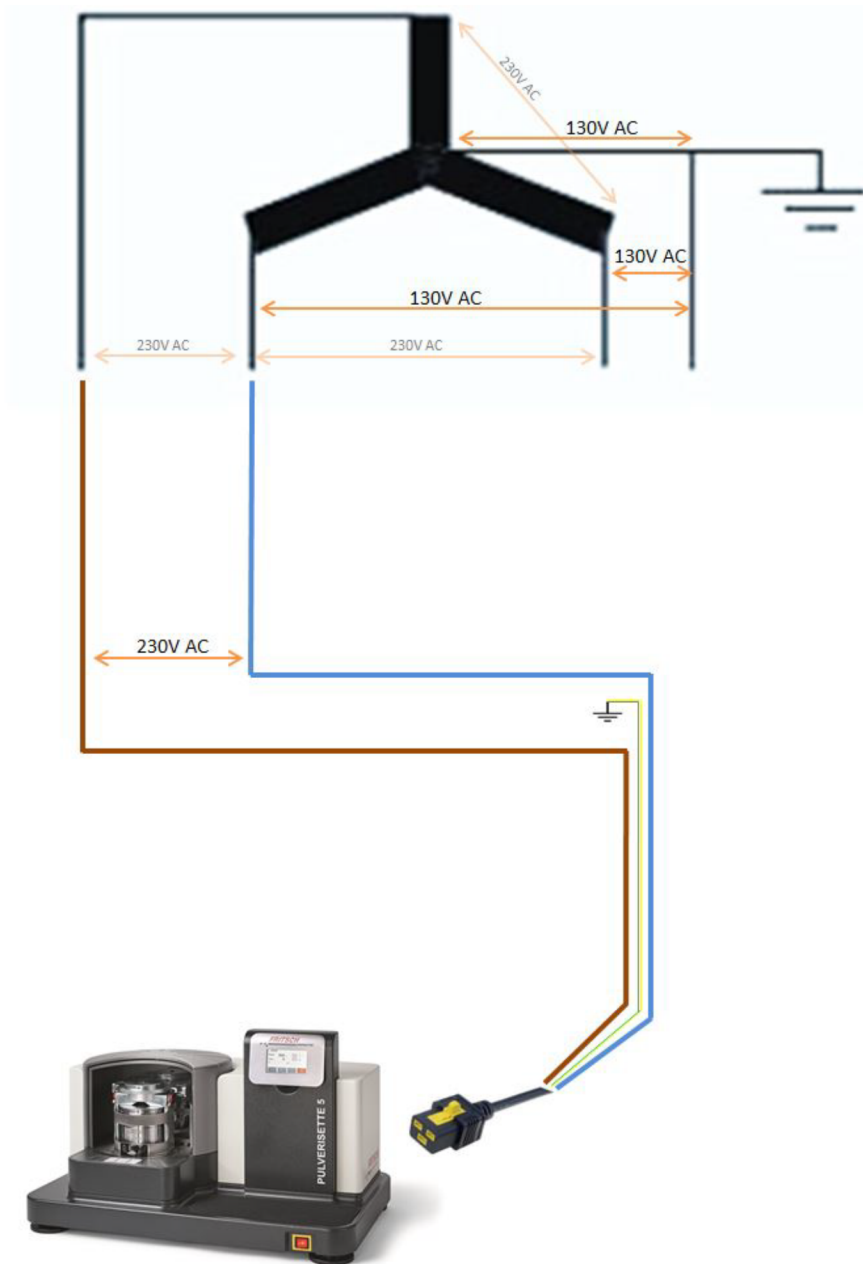

*If you have a question, please contact our technical service.
E-Mail: schmell@fritsch.de or telephone: +49 6784 70279.*

4.6 Electrical connection



 **DANGER**



Provide short-circuit protection!

Risk of damage due to short-circuits.

- Make sure that the socket is connected to a mains line protected with a residual current circuit breaker.

 **DANGER**



Mains voltage!

Changes to the connection line may only be made by a qualified person.

 **CAUTION**

Ignoring the values on the type plate may result in damage to the electrical and mechanical components.

Before establishing the connection, compare the voltage and current values stated on the type plate with the values of the mains system to be used.

1.  Plug the supplied power cord into the port on the back of the device.
2.  Then connect the device to the mains using the power cord!

 **NOTICE**

Fritsch mills are speed controlled. The devices are equipped for this with frequency converters. In order to comply with the EMC directive, many measures must be taken to prevent operational transient emissions.

The possible leakage currents resulting from filtering measures can trigger a conventional residual current circuit breaker in the mains line. **This is no defect!**

To prevent this, special residual current circuit breakers, which are adapted for operation with frequency converters, are commercially available.

Operation without a residual current switch is possible, but must be done in accordance with the relevant regulations.



5 Initial start-up

Perform initial start-up only after all work as described in [Chapter 4.1 'Installation' on page 17](#) has been carried out.

5.1 Switching on



- Connect the device to the mains.
- Switch on the device with the main switch (6) on the front of the device.
- The display lights up.

5.2 Function check

1. → Open the hood of the grinding chamber. (See [Chapter 6.4.2 'Bowl' on page 31](#)).
2. → Clamp two grinding bowls with of the same weight. (See [Chapter 6.5 'Clamping the grinding bowls' on page 31](#))
3. → Close the hood of the grinding chamber. (See [Chapter 6.4.2 'Bowl' on page 31](#)).
4. → Set the speed to 100 rpm and the grinding duration to 10 min. Press 'Start'. (See [Chapter 6.4.1 'Menu' on page 30](#)).
5. → The mill runs for 10 minutes at 100 rpm.
6. → Once the function check is completed, the mill stops and the grinding chamber opens.
7. → Remove the grinding bowls. (See [Chapter 6.10 'Removing the grinding bowls' on page 40](#)).

6 Using the device

DANGER

Before starting the machine, make sure that the grinding bowl has been tensioned correctly and that there are no loose parts inside the device. There is a risk of loose grinding bowls or parts being projected. Failure to observe this will render void the guarantee, and releases us from liability for any resulting damage to the device or personal injury.

NOTICE

During grinding, high temperatures and high pressure may appear in the grinding bowl.

In encased grinding bowls, the inserts are glued into the casing with a two-component construction adhesive.

The adhesive is resistant to temperatures up to approx. 140 °C. Above 140 °C, the adhesive will liquefy. That can cause irreparable damage to the insert. The grinding bowl will definitely be rendered unusable.



The device requires a start-up phase at the beginning in order to reach maximum performance. A well-filled and heavy grinding set may initially operate at a lower speed than after running for approximately 1 - 2 hours.

6.1 General information

The standard grinding bowls have been tested and approved for a static internal pressure of up to 18 bar.

Above this limit, the pressure is released via the lid by the mechanical components. This can lead to dirt in the interior!

Fast, dynamic pressure surges (e.g. explosions, very fast chemical reactions, etc.) result in damage to the grinding bowl and may lead to consequential damage to the machine.

6.2 Choice of grinding bowls and grinding balls

CAUTION

If the grinding elements used are not genuine accessories, we assume no guarantee and exclude all liability for damage to the device or for personal injury.

CAUTION

The grinding element is subject to normal wear during use. Before every grinding operation, check the wall thickness of the grinding bowls. In the event of severe wear, replace the grinding bowl. If this is not done, the prevailing high centrifugal forces during grinding may cause the grinding balls to damage the bowl insert. The grinding bowl will be rendered unusable. Failure to observe this will render void the guarantee and release us from liability for any resulting damage to the device or personal injury.

**! NOTICE**

Note that bowls made of agate are suitable only up to an internal pressure of 10 bar. A higher internal pressure could damage the grinding bowl and thus cause damage to the device.

! NOTICE

Each grinding process means wear to the grinding element. Therefore, please pay attention to what components the material of the grinding element contains and whether these could react with the sample. Such reactions may have consequences. A simple reaction with minor consequences may be, for example, the grinding of samples containing sulphur in the steel bowl, which contains iron. The iron released by abrasion can combine with sulphur and react to form iron sulphide. This can lead to black deposits on your grinding set.

The hardness and density (specific weight) of the grinding bowl and grinding balls used have to be greater than that of the material used to prevent excessive wear by abrasion.

Material (bowl and balls)	Main components of the material	Density in g/cm ³ High density means high impact energy!	Abrasion resistance	Use for grinding stock
Agate	(99.9% SiO ₂)	2.65	Good	Soft to medium-hard samples
Zirconium oxide	(96.2% ZrO ₂)	5.7	Very good	Fibrous, abrasive samples
Hardened, stainless steel	(16.0 - 18.0% Cr)	7.7	Fairly good	Medium-hard, brittle samples
Tungsten carbide	(93% WC + 6% Co)	14.9	Very good	Hard, abrasive samples

The grinding bowls and grinding balls made of zirconium oxide are resistant to acids - apart from hydrofluoric acid.

Normally choose a grinding bowl and grinding balls that are made of the same material.

Exception: Tungsten carbide balls (< 20 mm) may be temporarily (a few minutes) combined with grinding bowls made of hardened steel.

6.2.1 Size of the grinding balls

Type of feed material	Suitable ball diameter
Hard samples with a maximum feed size of 10 mm	20 mm
Average feed size of ≤ 5 mm	20 mm, 15 mm or 10 mm
Fine material < 0,1 - 0,5 mm	10 mm or smaller
Very fine material < 0,1 mm	3 mm or smaller
Homogenisation of dry or liquid samples	20 mm or smaller

Type of feed material	Suitable ball diameter
Homogenisation of viscous samples	20 mm

These are reference values: The size of bowls and grinding balls may need to be determined through experimentation.

! NOTICE

It is not advisable to mix balls of different diameters. If balls with different diameters are used, increased wear and damage to the grinding elements is to be expected.

6.2.2 Recommended number of balls per grinding bowl (independent of the material quantity)

A higher number of balls will reduce the grinding time and the grinding result will have a smaller particle size distribution.

Ball diameter (mm)	Grinding bowl volume (ml)	125	150	250	420	500
5	Number of balls (pcs)	600	900	1200	1800	2000
10	Number of balls (pcs)	35	40	50	80	100
15	Number of balls (pcs)	25	35	45	60	70
20	Number of balls (pcs)	9	12	15	20	25

Grinding balls ≤ 3 mm

Recommended ball mass per grinding bowl in grams:

Grinding bowl / Useful capacity (grinding stock)	150 ml 20 - 70 ml	250 ml 30 - 125 ml	500 ml 80 - 225 ml
Material			
Zirconium oxide	170 g	400 g	800 g
Hardened, stainless steel	350 g	500 g	1100 g
Hardmetal tungsten carbide	800 g	1000 g	2100 g



Grinding balls with a diameter ≤ 3 mm must be weighted out. The respective table provide you with the required mass per grinding bowl. If the specified ball filling will be reduced, increased wear should be expected.

These are reference figures: The number of balls may need to be determined through experimentation.

CAUTION

Do not leave the device unattended during operation, especially if grinding with large balls or grinding bowls of different weights. The device may move as a result of vibrations caused by high energy levels.

6.2.3 Average calculated weight of a ball

Ball diameter in mm		5	10	15	20
Material	Density in g/cm ³	Calculated weight of a ball in g			
Agate	2,65	0,17	1,39	4,68	11,1
Zirconium oxide	5,7	0,37	2,99	10,07	23,88
Hardened, stainless steel	7,7	0,50	4,03	13,60	32,25
Tungsten carbide	14,9	0,97	7,8	26,33	62,41

To determine the weight of the balls to be used, the "calculated weight of a ball" is multiplied by the "number" of balls required.

Example: A 250 ml agate bowl is to be filled with 1250 x 5 mm agate balls.

Calculation: $0.17 \text{ g} * 1250 \text{ pcs} \approx 212.5 \text{ g}$

212.5 g of grinding balls can be weighed and inserted in the grinding bowl, thus avoiding the time required for counting the balls.

6.3 Filling the grinding bowl

CAUTION



Do not fill in any dry ice or liquid nitrogen in the grinding bowls!

Adding dry ice or liquid nitrogen into the grinding bowls can lead to a sudden increase in volume with a high static pressure. This can result in an explosion of the grinding bowls.

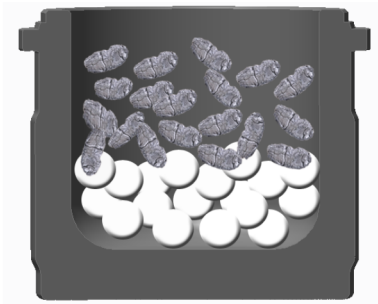

Do not fail to comply with the following sequence:

1. → Place the grinding balls in the empty bowl.
2. → Fill grinding stock onto the balls.

NOTICE

Make sure the sealing surface is clean and the seal is not damaged.

3. → Place the lid on the grinding bowl.

6.3.1 Closing the grinding bowl



1. → Once the grinding balls are placed in the bowl with the sample on top, put the lid on the grinding bowl.
2. → To prevent the sample from escaping while the grinding bowl is slowly opened, slip the supplied rubber band over the bowl so that the gap between lid and bowl is covered.

6.4 Settings on the control panel

i You can position the display in 3 different positions. To do this, grip the middle of the bottom edge of the display and pull forward. Pull the display up as far as it will go in order to return it to the initial position.

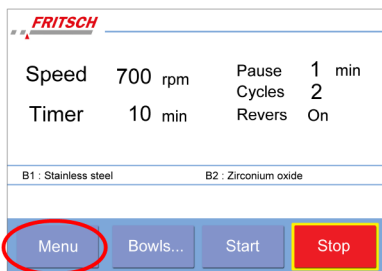

When the mill is switched on, the values of the last milling are displayed. You can make various settings as described below by clicking on the *[Menu]* button.



6.4.1 Menu

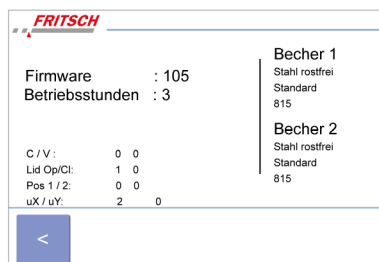
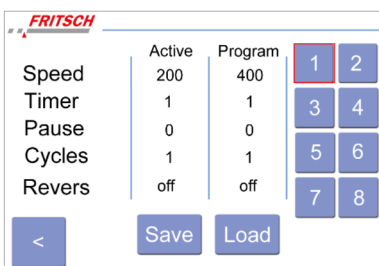
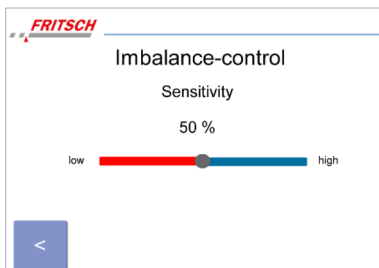
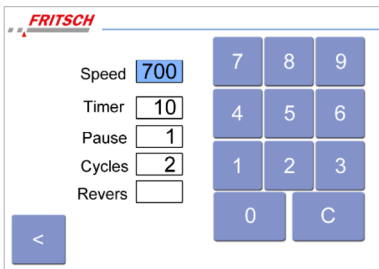

Parameter:

- Speed settings from 100 - 800 (rpm)
- For multiple cycles, you can specify pause times between the individual repetitions.
- You can also specify whether you would like to run the grinding bowls in the opposite direction (reverse) for each cycle.

To set the values of the various parameters, you must click on the corresponding fields and enter the values via the number field.

Language:

- Here you can set various languages.

Timer:

- The time entry refers to minutes or seconds, depending on the setting defined for the time mode. You can also enter a time delay. This means that grinding will start after a predefined period.

Unbalance-control:

- You can use the imbalance check to set the sensitivity of the imbalance sensor. A low percentage means low sensitivity and a high percentage means high sensitivity. This means that the device will switch off in the event of a high or low imbalance.

Program:

- Under program you can save the grinding values defined under Parameters as a program. You can save 8 different programs for your applications and load them via the 'Load' button.
- Press 1 - 8, depending on the position at which you would like to save the parameters using 'Save'.

Info:

- This screen displays information about the version of the software installed on the device, the current run-time and the bowls used.
- The area on the bottom left side is for reading the sensors and provides information for service technicians.

Using the device

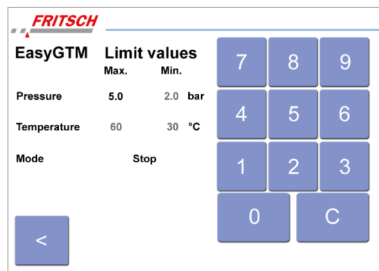

EasyGTM:

- Under the 'EasyGTM' item you can define various safety settings for handling the EasyGTM system.

6.4.2 Bowl

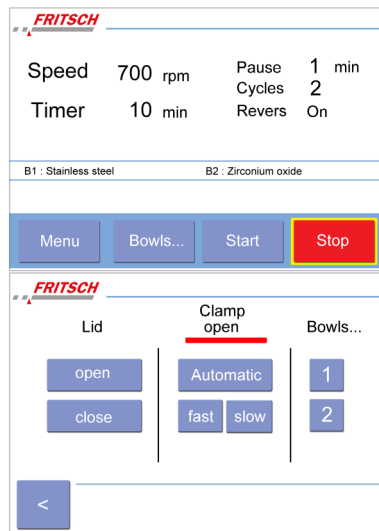

You can do the following from the 'Bowl...' menu item:

- Open and close the hood
- Open the clamping device of the grinding bowl automatically (slow), quickly (automatic) or slowly (manual)
- Change the positions of the grinding bowls



The automatic (slow) unclamping opens the grinding bowl clamping device within 5 minutes. This unclamping is intended to ensure a reliable and safe unclamping process for pressure regulation, without the user having to be present. The shield opens after about 2 minutes. However the bowl continues to be unclamped very slowly until it can be taken out of the bowl adapter after about 5 minutes.



The option of opening the clamping device of the grinding bowls quickly or slowly is used if pressure accumulates in the bowl, in which case the bowl can first be opened slowly to discharge the pressure. To open the bowl slowly, you must hold down the 'slow' button under 'Clamp open'. The bar underneath it shows you the progress.



To prevent injuries, the position of bowls can only be changed if the desired position number is held down until it is properly aligned in front.

6.5 Clamping the grinding bowls



- ➔ To insert the grinding bowl, the opening of the guide above the bowl must be facing in the direction of the grinding chamber.



The notch is on the front of the grinding bowl and must always face forward when the bowl is inserted.

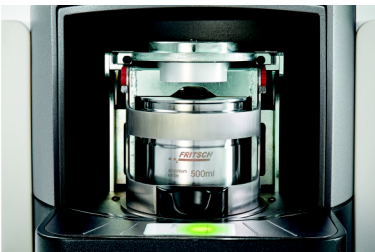
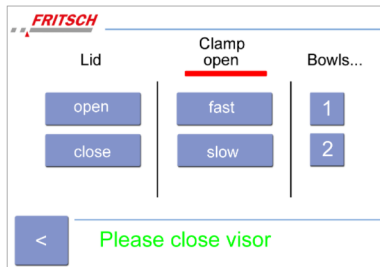
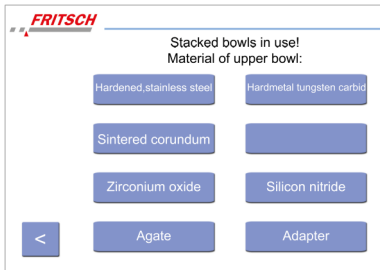

2. → Place the grinding bowl on the surface of the bowl detector (4) and slowly move the bowl over it until a short beep sounds and the field lights up green.

→ Bowl was detected.

3. → Push the bowl back as far as it will go.

4. → When using small grinding bowls, which are clamped with an adapter or a second bowl, a query which grinding bowl or whether an adapter was placed on the scanned bowl will be shown. Only the lower grinding bowl is recognized by the bowl recognition.

5. → 'Please close shield' appears on the display.

6. → Lower the shield as far as it will go and wait until the bowl detection field (4) lights up green.

→ Bowl has been properly clamped.



It takes several seconds to clamp the grinding bowl because an extremely large amount of pressure must be generated in order to securely clamp the bowl.



If the bowl detection field lights up red after several seconds, the bowl was not detected or the clamping device was released and re-clamped without re-scanning the bowl. Open the visor, remove the bowl and scan it again.

7. → Load bowl position 2 using the same procedure.

6.5.1 Clamping the 125 ml / 150 ml grinding bowls



When using the stacking ring, the heavier cup must be positioned at the bottom.

Using the device



To use a bowl, you need adapter (50.6837.00). As can be seen in the illustration, it is placed on the bowl and inserted and clamped in the device as described above.

When using two bowls, a stacking ring (50.6830.00) is needed that is placed between both bowls.

6.6 Mass balance

NOTICE

Extra weights such as the "GTM" system have to be balanced as well.



We generally recommend using two identical bowls with the same filling – i.e. the same number and size of balls, the same type and quantity of the sample.

- Load the laboratory planetary mill symmetrically.
- When using a single bowl with grinding balls and sample, use the counterweight as mass balance. See [➔ Procedure instructions on page 56](#)
- Alternatively, select an empty bowl as a counterweight. The empty bowl may be filled with sand for additional weight. Note that this mass balancing is only an approximation solution. The approximation solution may still result in an imbalance. This imbalance could result in a reduction of the rotational speed.

6.7 Factors with an impact on grinding

6.7.1 Running time (grinding duration)

To reduce the grinding time, you can use a grinding bowl and grinding balls with a higher density, and thus a higher impact energy.



CAUTION

Burn hazard!

Grinding bowls can get very hot after long grinding durations. Wear protective gloves for removal after grinding or during the grinding breaks.



Depending on the application, the grinding duration should be adapted to the development of heat in the bowls. The temperature inside the bowls can be much higher than the outer casing temperature.

CAUTION

The maximum temperature of the grinding bowl outer casing is 100 - 110 °C (agate, max. 70 - 80 °C).

The grinding duration is therefore based on the maximum bowl temperature. The grinding duration at which the temperature is not exceeded depends on the material, ball, and speed. For this reason, the user should determine it through experimentation.

Reference value

When grinding at high speeds and with large bowls, a grinding duration of one hour (depending on the temperature) should not be exceeded. Then allow the unit to cool down for half an hour to one hour.



To what extent the heating up of the material to be ground needs to be observed naturally depends on the corresponding sample in each individual case. Note → a longer duration may also require a long pause time for cooling down.

To reduce the grinding time, you can use a grinding bowl and grinding balls with a higher density, and thus a higher impact energy.

The mill can also run for several hours during low-speed operations for mixing and homogenisation.

Operation with an external time switch is not possible.

6.7.2 Speed

In order to reduce damage to the grinding bowls and balls, we have limited the speed for different ball sizes as follows:

Ball sizes	Speed limitation
1 mm and smaller	No limitation
5 mm	600 rpm
10 mm	500 rpm
20 mm	450 rpm
RFID / Bowl not recognised	450 rpm

Higher speeds shorten the grinding time and increase the percentage of fine particles.

Lower speeds increase the grinding time and lower the temperature, which can lead to fewer pauses. This means that the overall working time may remain the same. The wear is increased in this case though.



Fritsch recommends however to use the maximum speed and to plan for enough pauses so that the wear is minimised.



For thermally sensitive materials, the optimal rotational speed needs to be determined through experimentation.

6.7.3 Reverse mode

- Useful for mechanical alloying
- Improvement of the homogeneity of the sample



6.7.4 Number and size of the balls

! NOTICE

It is not advisable to mix balls of different diameters. If balls with different diameters are used, increased wear and damage to the grinding elements is to be expected.



You can find the recommended number and size of balls in [Chapter 6.2 'Choice of grinding bowls and grinding balls'](#) on page 25.

Larger balls are used for pre-crushing. (See [Chapter 6.2.2 'Recommended number of balls per grinding bowl \(independent of the material quantity\)'](#) on page 27).

To increase the proportion of fine particles, the large balls need to be replaced by smaller ball sizes during the course of the grinding process.

6.7.5 Weight of the balls (type of material)

A higher mass (specific weight) of the grinding balls accelerates grinding. (see table in [Chapter 6.2 'Choice of grinding bowls and grinding balls'](#) on page 25).

6.7.6 Dry grinding

! DANGER



Dust explosion!

There is a risk of spontaneous combustion especially for very fine metal oxides and a thus resulting dust explosion. Mind the external temperature and the pressure that can develop in the grinding bowl during the dry grinding.

! NOTICE

Dry grindings need to be checked in briefer intervals. Longer dry grindings, without pauses and checks, can cause the grinding set to gum up and to become damaged. In particular with agate, the grinding bowl and grinding balls can become damaged after a short grinding time.

At a particle size of less than 20 μm , the surface forces prevail. The grinding stock begins to stick.

Additional dry comminution can be achieved by adding surface-active substances to the material to be ground.

Examples (maximum amount to be added in mass %)

- Stearic acid 2-3 %
- Aerosil (fine-particle silicic acid) 0.5 - 2 %
- Quartz sand ~ 2 %
- Glass powder ~ 2 %

- Glycol (Ethylene glycol) ~ 0.1 - 0.5 % (Δ 5 - 25 droplets)
- Triethanolamine ~ 0.1 - 0.5 %

6.7.7 Wet grinding (grinding in a suspension)



⚠ DANGER
Explosion hazard! Ignition hazard!

The device is not explosion-protected. If flammable liquids are used, make sure that the heat developing in the grinding bowl does not reach the solvent's boiling point. Program appropriate cooling phases. If the vapour pressure is too high, vapours may escape and ignite.

If it can be avoided, we recommend using non-flammable liquids or liquids with a high boiling point. The boiling point should be above 80 °C and above 100 °C for a long grinding duration.

During the transition to grinding in suspension, you can add a liquid auxiliary agent with high boiling point and low vapour pressure, e.g. water, white spirits (boiling point 100 - 140°C), or alcohols with a high boiling point (e.g. isopropanol)

We recommend that you only use so much liquid that the suspension has the same consistency as motor oil. With this viscosity the best results can be achieved in most cases.



6.8 Conducting a grinding operation

Once you have completed all preparatory tasks described in → Chapter 6.2 'Choice of grinding bowls and grinding balls' on page 25, you can perform the grinding as follows:

1. → Check once again whether both bowl positions have been loaded and properly and clamped.
2. → Set the desired parameters via the control panel.
3. → Press 'Start' to close the grinding chamber and start the grinding.

! NOTICE

The ball size is requested at the beginning of the grinding operation to avoid damaging the grinding set and the device. This is because certain speeds are not permitted with some ball sizes and materials. Improper specification of the ball size can result in damage to the device and void the warranty.

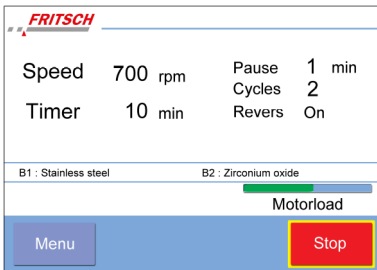

The motor load display gives you an indication of the motor load required to set the weight of the grinding sets in motion. When the motor starts up, it is normal for this bar to be in the red range. If the display is permanently in the red range, then this is due to the dynamic mass. This may result in reduced speed.



While in operation, the hood (3) remains locked, even during pause times, and the fan cools the interior.

6.8.1 Overload

In the event of an overload, the mill regulates the desired speed. The mill switches off if the overload continues for too long.

6.8.2 Switching off

! NOTICE

If the permissible maximum temperature in the bowl is exceeded during grinding, then the device must not be switched off with the lid closed. That could lead to heat accumulation in the machine, which could cause damage to the device.

Provide sufficient cooling by letting the mill continue to run at a speed of 100 rpm for approx. 20 - 30 min. or by shutting off the mill with the lid open.

! NOTICE

Remove the grinding bowls from the clamping device before switching off the device. Failure to do this can damage the clamping device of the grinding bowls.

1. → Press "STOP" on the display.
2. → When the drive comes to a stop, grinding station 1 is moved into the loading position and the hood opens automatically.
3. → If the device is put out of service for a lengthy period, close the hood and turn the device off at the main switch.

6.9 Cooling the grinding bowl



! WARNING



Burn hazard!

Grinding bowls can get very hot after long grinding durations. Wear protective gloves for removal after grinding or during the grinding breaks.

- When the hood is open (3), or
- In the programmed pause times with closed (locked) hood and the fan running.



6.10 Removing the grinding bowls

There are three ways of removing the bowls:

1. → The first is automatic and the safest method. With this method, the clamping device is slowly opened within 5 minutes of the method being activated. This process is intended to enable any pressure that has built up within the grinding bowl to escape very slowly.
2. → Otherwise, you can release the bowl quickly by pressing a button. Use this method only if you are sure that no pressure has built up within the grinding bowl.
3. → As a third option, if pressure has accumulated, you can open the clamping device slowly. To do this, you must hold down the "slow" button for an extended period. You can pull out the bowl to the front once the red progress bar has completely disappeared.

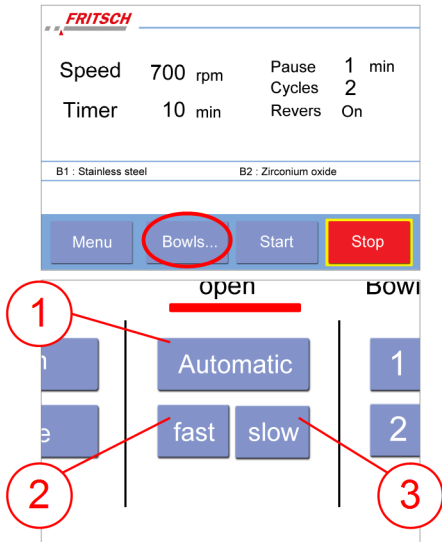

6.10.1 'Opening the clamping device'

Procedure for opening slowly:



1. → Press the 'slow' button until the red progress bar has completely disappeared. Only then is bowl fully released.



2. → Shield opens up; but the bowl is still clamped.

Using the device



- 3.** → Bowl has now been fully released.
Procedure during automatic opening:



A screen with a progress bar is displayed during automatic unclamping. This indicates approximately how much longer the unclamping process will take.

6.10.2 Removing the grinding bowl



! NOTICE

Be careful when taking out the grinding bowls as they could be very hot.

Once the shield is opened and the grinding bowl has been released completely, you can press it out from behind as shown.



6.11 Special emptying device for grinding bowls



Clean the emptying device before using it for the first time!

! NOTICE

The emptying device for suspensions can only be used for grinding with grinding balls larger than 0.5 mm.



To empty a grinding bowl after grinding in suspension, proceed as follows:

1. → Remove the lid from the grinding bowl.
2. → Pull the sieve up to the lid of the special emptying device. Then place the special emptying device on the grinding bowl. Make sure the lid sits correctly on the grinding bowl.
3. → Now slowly press the sieve tool to the bottom. If the suspension is too viscous, it may need to be diluted with a suitable fluid beforehand.



If your suspension has stood for a long time before the separation process and may have settled, it is recommended to agitate the suspension before the separation process, for example by making several slow vertical movements of the sieving tool.

4. → After the sieving tool has been pressed to the bottom, the suspension can be emptied through the large opening. To do this, tilt the cup over an appropriate storage container and carefully empty it. Hold the lid with your hands while doing this. Pay attention to the weight of the cup.
5. → If you want to extract as much residue as possible, we recommend rinsing several times with a neutral medium after the first emptying. The procedure is as explained starting from step 3.
6. → For cleaning, the emptying device can be completely dismantled and cleaned in the dishwasher.

! NOTICE

To avoid corrosion, we recommend immediate cleaning after the separation has been performed.

7 Accessories

7.1 Planetary mills - "MillControl" software



The P-5 premium Planetary Mill is controlled either at the device using the clearly arranged touch display or with the MillControl software. The software provides the user with all device controlling options and adds further aspects to the operation of the planetary ball mills, like the conduction of identical grinding cycles, but also grinding operations using the SOPs. In addition, you also have the option of having your grinding operations evaluated in detail in standardised reports with the relevant parameters. If an EASY-GTM system is used, all important data of this system can be displayed in the program.

Detailed information on the "MillControl" software is available in the corresponding software manual.

7.2 Gas Pressure and Temperature Measuring System

The EASY-GTM gas pressure and temperature measuring system is used to control the grinding process and for mechanical alloying.

! NOTICE

If grinding balls with a diameter of 1 mm or smaller are used, there is a risk of the through holes in the lid getting clogged, which could falsify the pressure and temperature measurement. If these ball sizes are used nevertheless, the grinding process must not be carried out unobserved. The intermediate lid should be checked at regular intervals during the grinding process. When the MillControl software is used, the pressure and temperature are displayed. If the pressure remains constant, the cause of this may be a clogged intermediate lid.

7.2.1 Case contents and system design



- | | | | |
|----|---------------------------------------|----|---------------------------|
| 1 | 2.6 Nm torque spanner + hexagonal bit | 11 | Lid |
| 3 | EASY-GTM system | 12 | Bowl |
| 4 | O-ring 88.49 x 3.53, Viton | 13 | Hose clamps |
| 5 | O-ring 21 x 2.5 | 14 | Compressed air hose |
| 6 | Coupling, gassing valve | 15 | Cleaning rods for valves |
| 7 | Hexagon offset screwdriver, 2.5 mm | 16 | Valve screwdriver |
| 8 | GTM support ring | 17 | Hexagon screwdriver, 3 mm |
| 9 | Transmission unit | 18 | Valve replacement screw |
| 10 | Valve insert | | |

7.2.2 Inserting / changing the battery

When inserting it for the first time and during subsequent replacement of the battery, proceed as follows:

1. → Lift off the support ring.



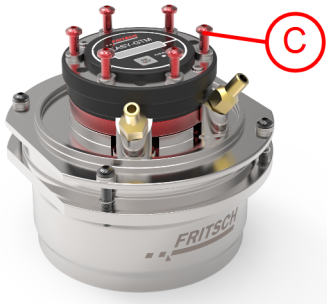

2. → Then release the 6 hexagon screws (C) for closing the system using a hexagon screwdriver (7). (See → Chapter 7.2.9 'Cleaning the EASY-GTM system' on page 51)



3. → Lift the measuring/transmission unit (9) off of the lid (11).



4. → The lock ring with the 6 hexagon screws can now be removed.



5. → Undo the two screws (D) of the battery compartment using a hexagon offset screwdriver, size 2.5 mm (7).



6. → Lift off the battery compartment lid and place it to the side. The battery compartment can be seen.

! NOTICE

Please note that the the battery (2) fits exactly in place and may need to be pushed in using a certain amount of force.

The service life of the battery (2) depends on the frequency of the radio protocols (see configuration) and essentially on the temperature inside the grinding bowl.

Also pay attention to the battery's charge level. If the battery's capacity falls below 10%, it should be replaced immediately.

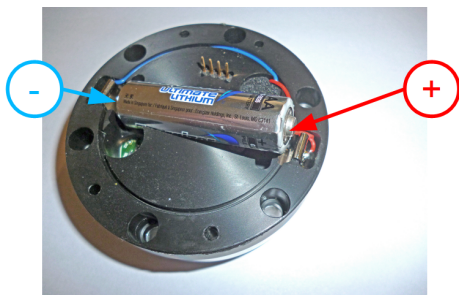

7. → Remove the old battery and insert the new battery (2). Battery type: 1.5 V / AA Lithium



Pay attention to the polarity when inserting the battery!

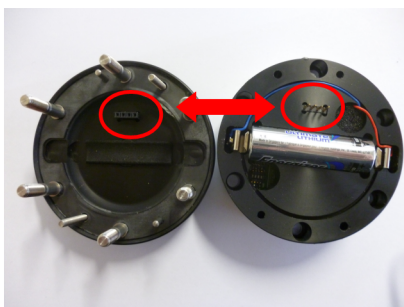

8. → Ensure that the plug contacts are in the correct position when closing the battery compartment!

7.2.3 Configuration of transmitter ID and data transmission frequency

The measuring/transmission unit is equipped with four configuration switches for setting the transmitter ID and data transmission frequency.

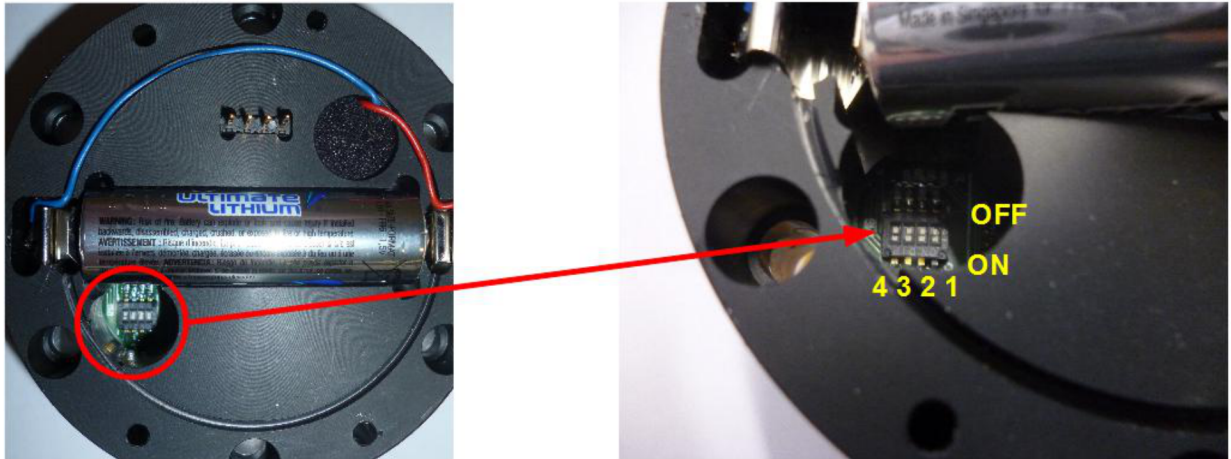

The switches illustrated are all in the **OFF** position (actuator cams set to OFF).

7.2.3.1 Adjustment options of the transmitter detection

In the delivery condition all switches are set to OFF. It is recognised that, in this case, bowl 1 and the transmission frequency of 1 second are the set values. The bowl with ID 1 must then also be inserted in the indicated position 1 of the mill. Similarly the EASY-GTM system with ID 2 must be positioned in position 2 of the mill.

ID	Switch 1	Switch 2
Transmitter no. 1	OFF	OFF
Transmitter no. 2	ON	OFF



If other switch settings are set, the EASY-GTM systems will not be recognised. Ensure that the settings shown in the table are used for your systems and that they are used in the correct position in the mill.

7.2.3.2 Transmission frequency setting options

Transmission every	Switch 3	Switch 4
1 second	OFF	OFF
½ second	ON	OFF
¼ second	OFF	ON



Transmission every	Switch 3	Switch 4
automatic	ON	ON

1-second transmission is the default value.

For automatic transmission, the 1 / ½ / ¼ second transmission frequency is switched over in the event of fast changes in pressure or temperature.

The data transmission frequency naturally also has an impact on the battery's service life.

1-second operation results in the longest time span.

The transmission frequency can also be checked visually: as soon as the transmission unit is switched on, the switch flashes each time data is transmitted.

7.2.4 Installation of the transmission unit on the EASY-GTM bowl

! NOTICE

The threaded holes inside the bowl, the passage holes and the Allen screws in the locking ring have to be cleaned thoroughly after each grinding to allow a safe fastening of the EASY-GTM system.

The EASY-GTM system must be assembled as follows before inserting the EASY-GTM system in the planetary micro mill:



1. → Put on the lid and secure it in place with the 4 hexagon screws!

If you want to use the EASY-GTM system without gassing valves, you will find valve replacement screws in the accessories case. Dismantle the valves and refit the valve replacement screws with the sealing rings.ingen der Ventile.



2. → Apply the transmitter with seal (5)!

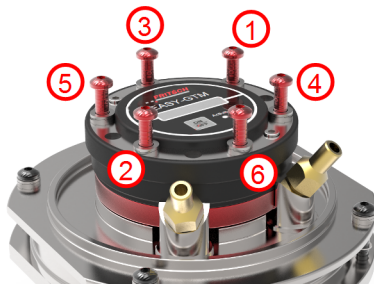

3. → Tighten the hexagon screws crosswise with a torque spanner (1) until it disengages! To be on the safe side, re-tighten all screws again after initially tightening them. All screws are secured against becoming loose during the grinding process once they have been tightened with the torque spanner as described.



Fritsch GmbH assumes no guarantee for damage caused by grinding with loose screws!

4. → Switch on the transmitter with the On/Off button (A) (LED flashes blue) and place the support ring on the bowl. Now position the bowl with the EASY-GTM system as described in Chapter "Clamping the grinding bowls".

! NOTICE

Check the fitting of the transmission unit again after inserting the bowl!

! NOTICE

You must check that the hexagon screws are sitting correctly during breaks in grinding. If screws have loosened, they must be re-tightened.

7.2.5 Installation of the receiver board in the P-5 premium

! DANGER



Before starting the installation, disconnect the mains plug and protect the device against being unintentionally switched back on.

Secure installation work with a warning sign.



1. → Remove the layer of rubber on the work surface and loosen the 6 screws with which the plate is attached to the housing.

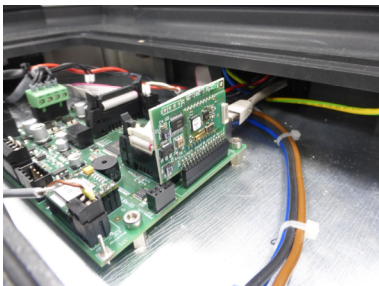

2. → Insert the receiver module in the corresponding slot. (As illustrated)

3. → Position the plate for the work surface, screw it down and put the rubber mat back on top.



When the receiver board is inserted, the P-5 premium automatically recognises when the EasyGTM is switched on.

Follow the following link to view a step-by-step instructional video for installing the receiver board. → [Click here](#).



You can also watch the video directly on our homepage on the product page of the device under VIDEOS - SUPPORT VIDEOS or via our Youtube channel 'FRITSCHE Milling and Sizing'.

7.2.6 Entering the temperature limit



DANGER
Do not exceed a maximum temperature of 125°C. Otherwise, the EASY-GTM system and the machine will be damaged.

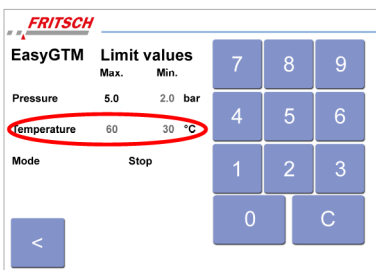

→ Click on the Max. and Min. fields in the 'Temperature' section and enter the maximum and minimum temperature. If the maximum temperature is reached (125° C), the device goes into cooling mode or stops until the temperature falls below the minimum temperature limit. Once the minimum temperature limit has been reached, grinding continues as normal.



If the max. temperature is reached, the device stops the grinding process and goes into cooling mode! Depending on the setting of the operating mode, see → Chapter 7.2.8 'Selecting the operating mode' on page 51, the device stops the grinding process and opens the grinding chamber cover or reduces the speed gradually until a minimum speed is reached in order to achieve an optimal cooling effect.

7.2.7 Entering the pressure limit

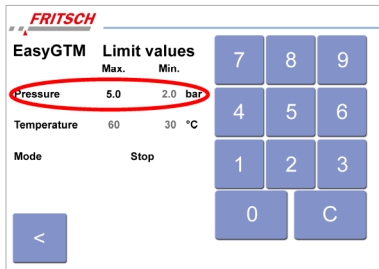

⚠ DANGER

Do not exceed a maximum pressure of 14 bar. Otherwise, the EASY-GTM system and the machine will be damaged.

→ Click on the Max. and Min. fields in the 'Pressure' section and enter the maximum and minimum pressure. If the minimum pressure (14 bar) is reached, the device goes into cooling mode or stops until the pressure falls below the minimum pressure limit. Once the minimum pressure limit has been reached, grinding continues as normal.



If the max. pressure is reached, the device stops the grinding process and goes into cooling mode! Depending on the setting of the operating mode, see → Chapter 7.2.8 'Selecting the operating mode' on page 51, the device stops the grinding process and opens the grinding chamber cover or reduces the speed gradually until a minimum speed is reached in order to achieve an optimal reduction of pressure.

7.2.8 Selecting the operating mode

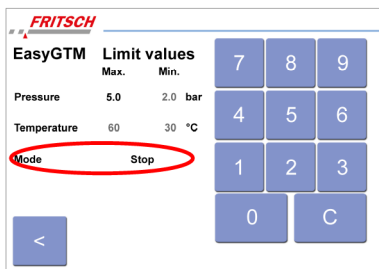

You can use the 'Mode' menu item to select how the P-5 premium is to respond to the temperature or pressure limit being reached.

Slow:

With this setting, the P-5 premium gradually reduces the speed down to a minimum speed. Once the lower temperature or pressure limit has been reached, P-5 premium grinding continues as normal.

Stop:

As soon as one of the two limits is reached, the ball mill shuts down immediately. If the limit is fallen short of, restart is disabled.

Press the "<" button to confirm all entries and return to the main menu.

7.2.9 Cleaning the EASY-GTM system

! NOTICE

The threaded holes inside the bowl, the passage holes and the Allen screws in the locking ring have to be cleaned thoroughly after each grinding to allow a safe fastening of the EASY-GTM system.

! NOTICE

The measuring/transmission unit may not be immersed in water. It can be rubbed down with a damp cloth if necessary.



Remove the lock ring (18), incl. screws, from the measuring/transmission unit and remove all soiling.

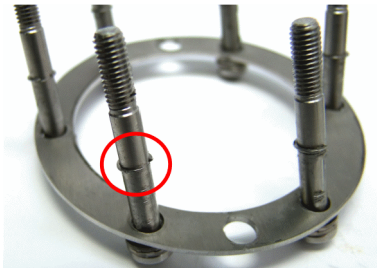

The screws are equipped with a circlip to prevent them from falling out of the lock ring (18). Ensure that the circlips are sitting correctly! (See illustration!)

The lid (11) and the bowl (10) can be cleaned under running water as described in Chapter "Cleaning".

7.2.9.1 Cleaning the sensor and replacing the seal

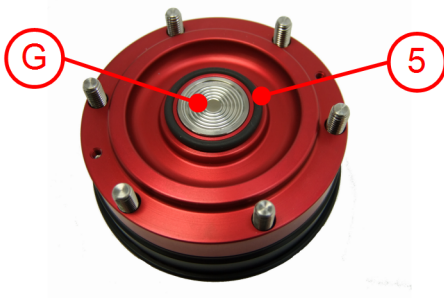

The sensor (G) must not be subjected to any mechanical stress. It is permitted to cleaning it with a wet cloth. The O-ring (5) can be replaced if necessary.

7.2.9.2 Battery arrangement

According to the "DIRECTIVE 2006/66/EC OF THE EUROPEAN PARLIAMENT AND COUNCIL as of 6th September 2006 on batteries and rechargeable batteries and on old batteries and old rechargeable batteries and for the annulment of Directive 91/157/EEC" and article 1, §18 and article 2 of the German Act on the re-definition of the waste legislation on the product responsibility for batteries and rechargeable batteries (BattG) as of 25.06.2009, we are legally obliged as the manufacturer to inform you as the consumer about the following:

The EASY-GTM product we sell contains a lithium battery, type AA, 1.5V, that can be discharged once.

When the battery is flat, it may not be disposed of along with household waste. Old batteries may contain harmful substances that can pollute the environment or damage your health. Please deliver the batteries to the regional recycling point/collection point. Please only place discharged/flat batteries in the containers intended for this purpose. Cover the terminals of lithium batteries with adhesive tape first.

All batteries and rechargeable batteries are reused. Valuable substances, such as zinc, iron and nickel can thus be recycled. Battery recycling is one of the easiest environmental protection measures. The crossed-out dustbin symbol means that (rechargeable) batteries may not be disposed of along with household waste.

You can, of course, also return discharged batteries - with sufficient postage - by post to:

Fritsch GmbH
Milling and Sizing
Industriestrasse 8
D-55743 Idar-Oberstein, Germany

For information on removing the battery, see → *Chapter 7.2.2 'Inserting / changing the battery' on page 44.*

7.3 Grinding in inert gas with gassing lid or screw-on lid

⚠ DANGER

Do not exceed a maximum pressure of 7 bar. Ignoring this pressure limit can cause damage to the accessories and the machine.

! NOTICE

Before every grinding operation, check the valves of the gassing lid ensuring that they are clean and properly secured. See chapter → *Chapter 7.3.5 'Cleaning the valves' on page 55.*

When grinding in inert gas, the same conditions apply regarding clamping and composition of grinding set and balls, as apply for standard grinding.

Two valves are screwed onto the gassing lid through which you can feed in inert gas (e.g. nitrogen) before switching on the mill.

The screw-on lids are for filling a grinding bowl in glove box with inert gas. The lids can be screwed shut and transported and clamped in completely sealed from a glove box into the mill.



7.3.1 Mounting the screw-on lid on the grinding bowl



- 1 Gassing lid with valves
- 2 Anti-slip cover with bowl lip
- 3 O-ring 107 x 2

1. → Put the bowl lip with the anti-slip cover over the grinding bowl from below, facing upward.
2. → To fix the bowl lip in place, then position the O-ring (3) beneath it. This must sit in the groove beneath the bowl lip. If positioned correctly, it will no longer be possible to move the bowl lip.
3. → Place the material to be ground into the bowl and screw down the lid using the 4 hexagon screws.
4. → Clamp the bowl as described in → *Chapter 6.5 'Clamping the grinding bowls' on page 31.*

7.3.2 Preparation for gassing

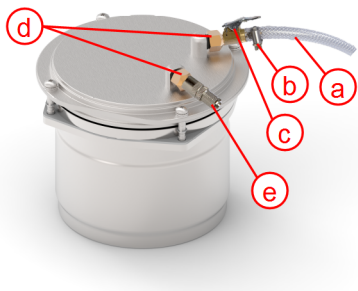

- a Gassing hose
- b Hose clamp
- c Coupling
- d Valves
- e Ventilation attachment

- Fill the grinding bowl with grinding balls and grinding stock. (See → Chapter 6.3 'Filling the grinding bowl' on page 29)
- Screw the grinding bowl to the gassing lid.
- Clamp the grinding bowl in the device (See → Chapter 6.5 'Clamping the grinding bowls' on page 31)

The following steps can also be completed in the glove box and subsequently clamped in the Planetary Mill:

- Connect the gassing hose (a) to the inert gas supply using the provided hose clamp (b).
- Screw the ventilation attachment (e) onto one of the two valves (d).
- Place the coupling (c) of the gassing hose on the free valve. When doing so, press the lever of the coupling and push the coupling along the neck of the valve until it goes no further. Release the lever.

7.3.3 Gassing

- Slowly open the inert gas supply.
- Press a thin object (e.g. hex key) onto the top of the ventilation attachment (e) so that the air can escape from the grinding bowl.
- The inert gas now purges the air from the grinding bowl.
- The duration of purging has to be determined through experimentation. It depends on grinding bowl size, filling, and gas supply, among other factors.
- To end purging, close the inert gas supply and release the ventilation attachment.
- Screw off the ventilation attachment.
- Remove the gassing hose. To do so, press the lever.

 **CAUTION**

Only switch on the device when both coupling and ventilation attachment have been removed.

Overpressure may occur during grinding!

7.3.4 Ventilate after grinding



 **CAUTION**

Always let the bowl cool down before ventilation. Hot gases and sample material may escape from the bowl during pressure equalisation, leading to serious burns.

→ Use protective gloves when ventilating!

- When the bowl has cooled down, remove the bowl from the device.
- Screw the ventilation attachment onto the valve.
Each valve can be used for aerating or de-aerating.
- For pressure equalisation (of the overpressure occurring because of grinding), carefully press on the ventilation attachment with a thin object (e.g. hex key).

7.3.5 Cleaning the valves

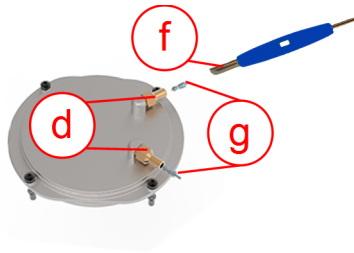

- f Valve screwdriver
- g Valve insert (84.6360.00)
- d Valves

Both valves (d) should be cleaned after every grinding!

- To do this, insert the thin end of the valve screwdriver (f) from above into the valve (d) and turn anti-clockwise.
- Screw out the valve insert (g).
- Depending on the soiling, clean the valve insert (g) with compressed air, or place it in a small glass container filled with alcohol and clean in an ultrasonic cleaner (LABORETTE 17) and then dry carefully.
- After the two valve inserts have been removed, the two valve holders can be cleaned with compressed air from above the lid.

7.4 Compl. counterweight

The device is generally subject to a specific imbalance during operation. To keep this imbalance as low as possible, all rotating masses in the system must be balanced as completely as possible.

To ensure optimum mass balancing (imbalance correction) of the device, identical bowls and identical contents must always be used at both grinding stations (→ Chapter 6.6 'Mass balance' on page 33).

The counterweight is used for weight balancing if only one grinding bowl is inserted with a sample in the P-5 premium.

7.4.1 Design

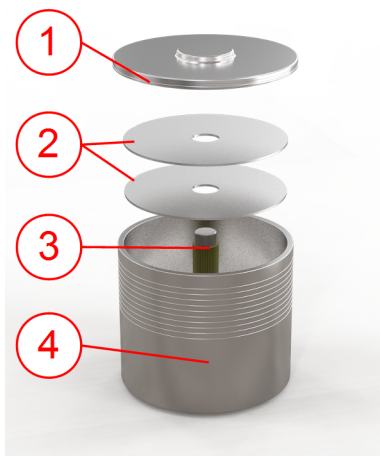

- 1 Lid
- 2 Counterweights
- 3 Guide shaft for counterweights
- 4 Bowl for counterweights

7.4.2 Handling



We generally recommend using two identical bowls with the same filling – i.e. the same number and size of balls, the same type and quantity of the sample.

1. → Determine the total weight of the grinding bowl filled with grinding stock and grinding balls, including lid.
2. → Attach enough counterweight disks to the counterweight so that the counterweight with lid equals the weight of the previously weighed bowl.
3. → Once the counterweight with lid has the necessary weight, insert it opposite of the bowl with the attached grinding stock and balls and clamp the counterweight as described in chapter → *Chapter 6.5 'Clamping the grinding bowls' on page 31.*
 - ➔ The counterweight now serves as the basis for determining the exact weight.



As the grinding bowl with the balls and the sample contains two different masses, a fixed mass and a movable mass, the counterweight, which has only one fixed mass, must be adapted to the loaded grinding bowl.

4. → If the mill has an imbalance, place further counterweights in the bowl disc by disc until the mill is running smoothly. This fine adjustment must be carried out at the maximum speed for the ball size and bowl type used. If the vibrations of the mill start to increase again, remove a disc from the counterweight. You have now determined the optimum counterweight for your grinding process.



If the quantity of the sample to be comminuted is limited, use a blank sample of the same quantity as the sample to be comminuted to adjust the counterweight.

7.5 Single-use grinding containers

! NOTICE

Do not exceed a maximum temperature of 60 °C.

! NOTICE

When using solvents or other liquids, pay attention to the resistance list and boiling points of the single-use grinding vessels. The container is made of polypropylene, the lid of high-density polyethylene.



! NOTICE

Make sure the mass balance is correct. We generally recommend using two identically equipped grinding bowls. See also → Chapter 6.6 'Mass balance' on page 33.

- Sample volume of 20 - 100 ml when using one to five grinding vessels
- Used for grinding and mixing soft to medium-hard materials.
- The single-use grinding vessels are intended for one-time use only. The vessels must be replaced after each grinding process.
- Do not exceed the maximum cycle time of 5 minutes. Then check for leaks.



The following values are guide values and must be determined empirically depending on the application.

Maximum number of different ball sizes:

Ball diameter (mm)	Ball quantity	Material
10	10 pcs.	Agate and zirconium oxide
5	80 pcs.	Agate and zirconium oxide
3 mm and smaller	30 g	Zirconium oxide

Filling and inserting the grinding vessels:

1. → Fill the grinding balls into the vessel.
2. → Add a maximum 20 ml of sample.
3. → Screw on the lid tightly.
4. → Insert the grinding vessel into the grinding bowl.
5. → Place the grinding bowl lid on the grinding bowl and proceed as per → Chapter 6.5 'Clamping the grinding bowls' on page 31.

6. →



To remove the single-use containers, take the grinding bowl in your hand and pull out the single-use containers. There are holes on the underside of the grinding bowl to prevent the containers from being vacuumed, making it easier to remove them.



7.6 Optional accessories

Grinding bowl made of:	420 - 500 ml	250 ml	125 - 150 ml
Agate - SiO ₂ - with steel casing	50.6400.00	50.6610.00	50.6840.00
Zirconium oxide - ZrO ₂ - with steel casing	50.6490.00	50.6700.00	50.6900.00
Hardened, stainless steel - FeCr - with steel casing	50.6550.00	50.6760.00	50.6920.00
Hardmetal tungsten carbide - WC - with steel casing	50.6580.00	50.6790.00	50.6940.00

Spare parts for grinding bowl:	
Replacement grinding bowl sealing band	50.6980.24
Replacement seal for all grinding bowls P-5 premium	84.0163.15
Adapter for all grinding bowls 125 - 150 ml volume	50.6837.00
Stacking ring for grinding bowls 125 - 150 ml volume	50.6830.00

Grinding balls made of:	20 mm	15 mm	10 mm	5 mm
Agate - SiO ₂ - polished	55.0200.05	55.0150.05	55.0100.05	55.0050.05
Zirconium oxide - ZrO ₂	55.0200.27	55.0150.27	55.0100.27	55.0050.27
Hardened, stainless steel - Fe-Cr	55.0200.09	55.0150.09	55.0100.09	55.0050.09
Hardmetal tungsten carbide - WC	55.0200.08	55.0150.08	55.0100.08	55.0050.08

Grinding balls ≤ 3 mm	
3 mm Ø zirconium oxide - ZrO ₂	55.0030.27
2 mm Ø zirconium oxide - ZrO ₂	55.0020.27
1.5 mm Ø zirconium oxide - ZrO ₂	55.0015.27
1 mm Ø zirconium oxide - ZrO ₂	55.0010.27
0.5 mm Ø zirconium oxide - ZrO ₂	55.0005.27
0.1 mm Ø zirconium oxide - ZrO ₂	55.0001.27
3 mm Ø hardmetal tungsten carbide - WC	55.0030.08
1.6 mm Ø hardmetal tungsten carbide - WC	55.0016.08
0.6 mm Ø hardmetal tungsten carbide - WC	55.0006.08

Single-use grinding vessels	
Aluminium grinding bowl with 5 single-use grinding vessels of 25 ml volume	50.6436.00
Set of single-use grinding vessels of 25 ml volume with lid (set = 10 pieces)	50.6437.00
MillControl software for automatic control and validation of the grinding by <i>premium</i> Planetary Mill	
MillControl software	83.5605.00
EASY-GTM gas pressure and temperature measuring system for monitoring the grinding process	
Receiver unit - plug-in board and MillControl software	81.0013.00
250 ml grinding bowl made of zirconium oxide - ZrO ₂ - with special lid with gassing valves and transmitter	50.9250.00
250 ml grinding bowl made of special, hardened stainless steel - FeCr - with special lid with gassing valves and transmitter	50.9280.00
250 ml grinding bowl made of hardmetal tungsten carbide - WC - with special lid with gassing valves and transmitter	50.9310.00
Accessories for grinding in inert gas and for mechanical alloying - gassing lid with valves and seal for grinding bowls of 500 ml, 420 ml, 250 ml, 150 ml and 125 ml volume	
Agate - SiO ₂ - with steel casing	50.6407.00
Zirconium oxide - ZrO ₂ - with steel casing	50.6497.00
Hardened, stainless steel - FeCr - with steel casing	50.6557.00
Hardmetal tungsten carbide - WC - with steel casing	50.6587.00
Screw-on grinding bowl lid with seal for all <i>premium</i> grinding bowls 500 ml, 420 ml, 250 ml, 150 ml and 125 ml volume	
Agate - SiO ₂ - with steel casing	50.6405.00
Zirconium oxide - ZrO ₂ - with steel casing	50.6495.00
Hardened, stainless steel - FeCr - with steel casing	50.6555.00
Hardmetal tungsten carbide - WC - with steel casing	50.6585.00
Certification	
IQ/OQ documentation (pre-printed - implementation not included in the price)	96.0310.00



Should you require spare parts for maintenance or repair work, please contact Fritsch GmbH or the representative that is responsible for you in your country.

8 Cleaning



DANGER

Mains voltage!

- Before beginning with cleaning work, disconnect the mains plug and protect the device against being unintentionally switched back on!
- Do not allow any liquids to flow into the device.
- Indicate cleaning work with warning signs.
- Put safety equipment back into operation after cleaning work.



When cleaning the entire device, adhere to the guidelines of the Accident Prevention Regulation (BGV A3) - especially when the device has been set up in a dusty environment or when the grinding stock processed produces dust.

8.1 Grinding elements

NOTICE

- Cool grinding elements made of agate and zirconium oxide slowly and carefully.
- Do not heat agate elements in a microwave under any circumstances (heating is too fast).
They should never be exposed to thermal shocks as this could cause irreparable damage to the parts → They will burst apart explosively.

NOTICE

The counterweight may only be brushed off or rubbed off with a damp cloth.

- Clean the grinding bowl and grinding balls each time after using them: e.g. clean them under running water using a brush and a commercially available cleaning agent.
- Half fill the grinding bowl with grinding balls, sand and water, and run for 2 to 3 minutes in the Planetary Mill at maximum speed.
- Cleaning with an ultrasonic cleaner is permitted.
- For sterilisation in the heat cabinet, only heat the grinding elements up to 100 °C.

8.2 Device

- The Planetary Mill can be wiped down with a damp cloth when it is switched off.



9 Maintenance

 **DANGER**



Mains voltage

- Before beginning with maintenance work, unplug the mains plug and protect the device against being unintentionally switched back on again!
- Indicate maintenance work with warning signs.
- Maintenance work may only be performed by specialised personnel.
- Put safety equipment back into operation after maintenance or repair work



We recommend keeping a safety logbook → Chapter 13 'Safety logbook' on page 68, where all work (maintenance, repairs.....) performed on the device is entered.



The most important element of maintenance is regular cleaning!

10 Disposal

It is hereby confirmed that FRITSCH has implemented the directive 2002/95/EC of the European Parliament and Council from 27th January 2003 for the limitation of the use of certain dangerous substances in electrical and electronic devices.

FRITSCH has registered the following categories according to the German electrical and electronic equipment act, section 6, paragraph 1, clause 1 and section 17, paragraphs 1 and 2:

Mills and devices for the preparation of samples have been registered under category 6 for electrical and electronic tools (except for large stationary industrial tools).

Analytical devices have been registered under category 9, monitoring and control instruments.

It has been accepted that FRITSCH is operating only in the business-to-business area. The German registration number for FRITSCH is WEEE reg. no. DE 60198769

FRITSCH WEEE coverage

Since the registration of FRITSCH is classified for bilateral transactions, no legal recycling or disposal process is described. FRITSCH is not obliged to take back used FRITSCH devices.

FRITSCH declares it is prepared to take back used FRITSCH devices for recycling or disposal free of charge whenever a new device is purchased. The used FRITSCH device must be delivered free of charge to a FRITSCH establishment.

In all other cases FRITSCH takes back used FRITSCH devices for recycling or disposal only against payment.



11 Guarantee terms

Guarantee period

As manufacturer, FRITSCH GmbH provides – above and beyond any guarantee claims against the seller – a guaranty valid for the duration of two years from the date of issue of the guarantee certificate supplied with the device.

Within this guarantee period, we shall remedy all deficiencies due to material or manufacturing defects free of charge. Rectification may take the form of either repair or replacement of the device, at our sole discretion. The guarantee may be redeemed in all countries in which this FRITSCH device is sold with our authorisation.

Conditions for claims against the guarantee

This guarantee is subject to the condition that the device is operated according to the instructions for use / operating manual and its intended use.

Claims against the guarantee must include presentation of the original receipt, stating the date of purchase and name of the dealer, together with the complete device type and serial number.

Reasons for loss of the guarantee

The guarantee will not be granted in cases where:

- Damage has arisen due to normal wear and tear, especially for wear parts, such as: Crushing jaws, support walls, grinding bowls, grinding balls, sieve plates, brush strips, grinding sets, grinding disks, rotors, sieve rings, pin inserts, conversion kits, sieve inserts, bottom sieves, grinding inserts, cutting tools, sieve cassettes, sieve and measuring cell glasses.
- Repairs, adaptations or modifications were made to the device by unauthorized persons or companies.
- The device was not used in a laboratory environment and/or has been used in continuous operation.
- Damage is present due to external factors (lightning, water, fire or similar) or improper handling.
- Damage is present that only insubstantially affects the value or proper functioning of the device.
- The device type or serial number on the device has been changed, deleted, removed or in any other way rendered illegible
- The above-mentioned documents have been changed in any way or rendered illegible.

Costs not covered by the guarantee

This guarantee excludes any costs for transport, packaging or travel that accrue in the event the product must be sent to us or in the event that one of our specialist technicians is required to come to your site. Any servicing done by persons not authorised by us and any use of parts that are not original FRITSCH accessories and spare parts will void the guarantee.

Further information about the guarantee

The guarantee period will neither extend nor will a new period of guarantee begin in the event that a claim is placed against the guarantee.

Please provide a detailed description of the type of error or the complaint. If no error description is enclosed, we shall interpret the shipment as an assignment to remedy all recognisable errors or faults, including those not covered by the guarantee. Errors or faults not covered by the guarantee shall in this case be rectified at cost.

We recommend reading the operating manual before contacting us or your dealer, in order to avoid unnecessary inconvenience.

Ownership of defective parts is transferred to us with the delivery of the replacement part; the defective part shall be returned to us at buyer's expense.

! NOTICE

Please note that in the event that the device must be returned, the device must be shipped in the original Fritsch packaging. Fritsch GmbH denies all liability for any damage due to improper packaging (packaging not from Fritsch).

Any enquiries must include a reference to the serial number imprinted on the type plate.



12 Exclusion of liability

Before using the product, be sure to have read and understood this operating manual.

The use of the product requires technical knowledge; only commercial use is permitted.

The product may be used exclusively within the scope of applications set down in this operating manual and within the framework of guidelines put forth in this operating manual and must be subject to regular maintenance. In case of non-compliance, improper use or improper maintenance, the customer assumes full liability for the functional capability of the product and for damage or injury arising from violating these obligations.

The contents of this operating manual are subject in entirety to copyright law. This operating manual and its contents may not be copied, further distributed or stored in any form, in part or in whole, without the prior written consent of Fritsch.

This operating manual has been prepared to the best of our knowledge and checked for accuracy at the time of printing. FRITSCH GMBH assumes no guarantee or liability whatsoever for the accuracy or completeness of the contents of this operating manual, including but not limited to the implied warranties of merchantability and fitness for a particular purpose, unless liability is expressly prescribed by applicable laws or jurisprudence.

FRITSCH GMBH expressly reserves the right to modify and/or update this operating manual without prior notice. The same applies to modifications and improvements to the products described in this operating manual. It is the responsibility of the user to ensure that they have the current version of this operating manual. For more information, please contact your local FRITSCH GMBH distributor or Fritsch GmbH, Industriestr. 8, D-55473 Idar-Oberstein.

Not all parts shown here are necessarily installed in the product. The buyer is not entitled to delivery of these parts. If interested, please contact your local FRITSCH GMBH distributor or Fritsch GmbH, Industriestr. 8, D-55473 Idar-Oberstein.

FRITSCH GMBH takes the greatest care to ensure that the quality, reliability and safety of your products are continuously improved and adapted to the state of the art. The supplied products as well as this operating manual conform to the current state of the art when they leave the sphere of influence of FRITSCH GMBH.

By using the product the customer agrees with this and recognizes that defects, malfunctions or errors cannot be completely excluded. To prevent risk of damage to persons or property or of other direct or indirect damage, resulting from this or other causes, the customer must implement sufficient and comprehensive safety measures for working with the product.

Fritsch GmbH excludes any liability, warranty, or other obligation to compensate for damages, regardless of whether this liability, warranty, or other obligation is explicit or implicit, contractual or arising from unlawful acts or prescribed contractually, by law, or otherwise. In no event shall the buyer be entitled to any compensation from Fritsch GmbH for any special, direct, indirect, coincidental or consequential damage, including but not limited to lost profits, lost savings, lost sales or financial loss of any kind or for compensation of third parties, for downtimes, for lost goodwill, for damage to or replacement of equipment and property, for costs or restoration of materials or goods related to the product or the use of our products, for other damage

or injury to persons (including fatal injuries) or similar. The above exclusion of liability is limited by mandatory liability as prescribed by laws or jurisprudence. Liability for negligence is excluded in all cases.

No permission is given expressly, implicitly or otherwise for the use of patents, brands or other copyrights. We also assume no liability for copyright infringements or infringements of the rights of third parties arising from the use of this product.

Neither compliance with this operating manual nor the conditions and methods used during installation, operation, use and maintenance of the product can be monitored by Fritsch GmbH. Improper execution of the installation can result in property damage and thus endanger persons. Therefore, we assume absolutely no responsibility or liability for loss, damage or costs that result from errors at installation, improper operation or improper use or improper maintenance or are in any way connected to these.



© 2018

Fritsch GmbH

Industriestraße 8

D - 55743 Idar-Oberstein

Telephone: +49 6784 70-0

Email: info@fritsch.de

Internet: www.fritsch.de